

**TEST REPORT**

**AS/NZS 4777.2**

**Grid connection of energy systems via inverters  
Part 2: Inverter requirements**

**Report Reference No.** .....: 180903076GZU-004

**Tested by (name + signature)** .....: Jason Fu  
Senior. Project Engineer

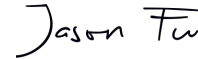

**Approved by (name + signature)** .....: Tommy Zhong  
Assistant Technical Manager



**Date of issue** .....: 14 Nov., 2018

**Contents** .....: 53 pages

**Testing Laboratory** .....: Intertek Testing Services Shenzhen Ltd. Guangzhou Branch

**Address** .....: Block E, No.7-2 Guang Dong Software Science Park, Caipin Road,  
Guangzhou Science City, GliETDD, Guangzhou, China

**Testing location / procedure** .....: TL  SMT  TMP

**Testing location / address** .....: The same as testing laboratory

**Applicant's name** .....: Shenzhen SOFAR SOLAR Co., Ltd.

**Address** .....: 5/F, Building 4, Antongda Industrial Park, No.1 Liuxian Avenue, Xin'an  
Street, Bao'an District, Shenzhen City, Shenzhen City, Guangdong  
Province, P.R. China

**Test specification:**

**Standard** .....: AS/NZS 4777.2: 2015

**Test procedure** .....: Australia registration

**Non-standard test method** .....: N/A

**Test Report Form/blank test report**

**Test Report Form No.** .....: TTRF\_AS/NZS\_4777.2B

**TRF Originator** .....: Intertek Guangzhou

**Master TRF** .....: Dated 2015-11

**Copyright © 2003 IEC System for Conformity Testing and Certification of Electrical Equipment (IECEE), Geneva, Switzerland. All rights reserved.**

This publication may be reproduced in whole or in part for non-commercial purposes as long as the IECEE is acknowledged as copyright owner and source of the material. IECEE takes no responsibility for and will not assume liability for damages resulting from the reader's interpretation of the reproduced material due to its placement and context.

**Test item description** .....: Hybrid inverter

**Trade Mark** .....



**Manufacturer** .....: Same as applicant

**Model/Type reference** .....: HYD 6000-ES, HYD 5000-ES, HYD 4000-ES,  
HYD 3600-ES, HYD 3000-ES

**Ratings** .....: See ratings in page 4 for details

<b>Test item particulars</b> .....	
Classification of installation and use .....	Mounting on wall and outdoor used
Supply Connection .....	Permanent connection
<b>Possible test case verdicts:</b>	
- test case does not apply to the test object .....	N/A
- test object does meet the requirement .....	P(Pass)
- test object does not meet the requirement .....	F(Fail)
<b>Testing</b> .....	
Date of receipt of test item .....	03 Sep., 2018
Date (s) of performance of tests .....	03 Sep., 2018 – 20 Oct., 2018
<b>General remarks:</b>	
<p>The test results presented in this report relate only to the object tested.          This report shall not be reproduced, except in full, without the written approval of the Issuing testing laboratory.</p> <p>"(see Enclosure #)" refers to additional information appended to the report.          "(see appended table)" refers to a table appended to the report.          Throughout this report a comma is used as the decimal separator.</p> <p>When determining for test conclusion, measurement uncertainty of tests has been considered.          This report is for the exclusive use of Intertek's Client and is provided pursuant to the agreement between Intertek and its Client. Intertek's responsibility and liability are limited to the terms and conditions of the agreement. Intertek assumes no liability to any party, other than to the Client in accordance with the agreement, for any loss, expense or damage occasioned by the use of this report. Only the Client is authorized to permit copying or distribution of this report and then only in its entirety. Any use of the Intertek name or one of its marks for the sale or advertisement of the tested material, product or service must first be approved in writing by Intertek. The observations and test results in this report are relevant only to the sample tested. This report by itself does not imply that the material, product, or service is or has ever been under an Intertek certification program.          The test report only allows to be revised only within the report defined retention period unless standard or regulation was withdrawn or invalid.          The test results presented in this report relate only to the item tested. The results indicate that the specimen complies with standard" AS/NZS 4777.2: 2015".</p> <p>Factory: same as applicant</p> <p>This report shall be used together with report No. 180903076GZU-002 and 180903076GZU-003.</p>	

**General product information:**

The unit is a single-phase hybrid inverter, it can convert the high PV voltage and Grid voltage to low DC for charge battery, also convert PV voltage and battery voltage to AC output .

The unit is providing EMC filtering at the PV and battery side. It does provide galvanic separation from PV side to Grid. The battery circuit does provide high frequency isolation to PV side and AC mains.

The unit has two controllers. the master DSP controller monitor the charge or discharge status; measure the PV voltage and current, battery voltage, bus voltage, buck voltage and current, AC voltage, current, GFCI and frequency.

The slave DSP controller monitor AC voltage , current ,frequency , GFCI and communicate with the master controller

The master DSP and slave DSP are used together to control relay open or close, if the single fault on one DSP, the other one DSP can be capable to open the relay, so that still providing safety means

The topology diagram as following:

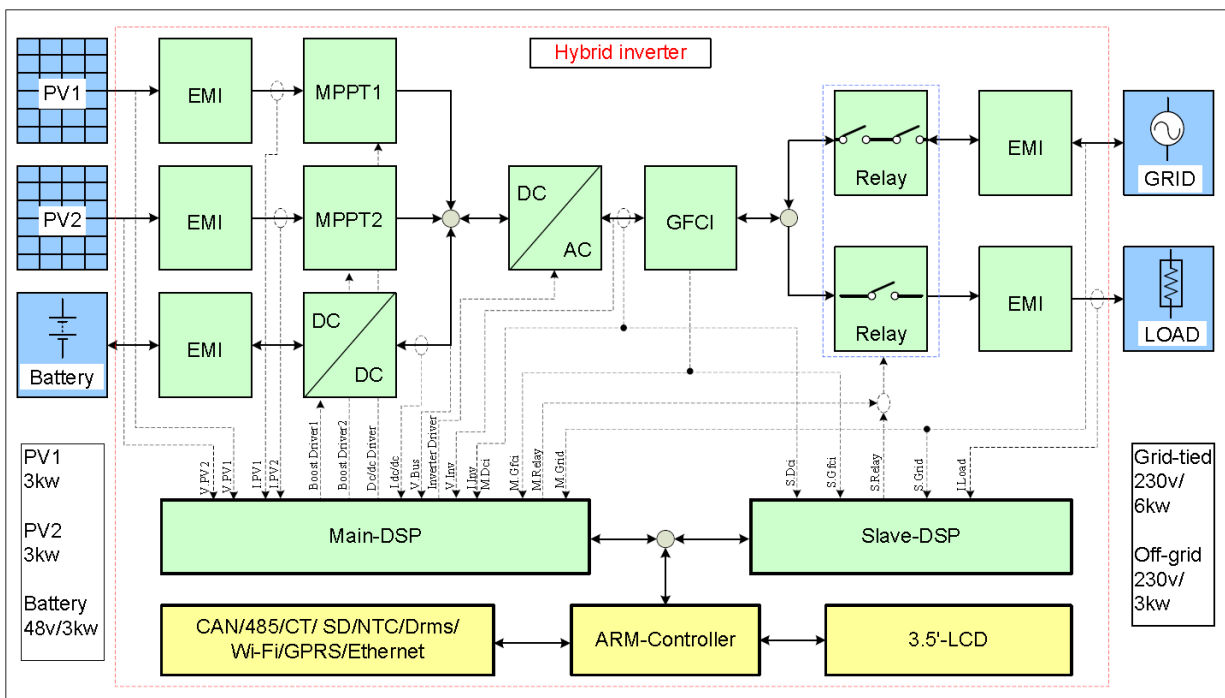

**Model differences:**

The models HYD 3000-ES, HYD 3600-ES, HYD 4000-ES , HYD 5000-ES and HYD 6000-ES are completely identical and output power derated by software, except for the following table.

Model	HYD 6000-ES	HYD 5000-ES	HYD 4000-ES	HYD 3600-ES	HYD 3000-ES
R332, R334, R336	0Ω, NC, 0Ω		NC, 0Ω, NC		
Bus capacitance	8pcs		6pcs		
INV inductor	0.75mH		1.035mH		
R123, R132	1.5KΩ, 1.5KΩ		499Ω, 499Ω		

Other than special notes, typical model HYD 6000-ES used as representative for testing in this report.

Version of software: V1.00

The type of grid source: simulated test grid

The impedance of the grid source: 0.1Ω

**Rating:**

Model	HYD 3000-ES	HYD 3600-ES	HYD 4000-ES	HYD 5000-ES	HYD 6000-ES
Max. DC Input Voltage	600 d.c.V				
Max. PV Isc	2 X 15 d.c.A				
Battery Type	Lead-acid, Lithium-ion				
Battery Voltage Range	42-58 d.c.V				
Max. Charging Current	65 d.c.A				
Max. Discharging Current	70 d.c.A				
Max. Charging & Discharging Power	3000VA				
Nominal Grid voltage	230 a.c.V				
Nominal Output Voltage (backup)	230 a.c.V				
Max. output current	13.7 a.c.A	16 a.c.A	18.2 a.c.A	22.8 a.c.A	27.3 a.c.A
Nominal Grid Frequency	50Hz				
Power Factor	1 (adjustable +/-0.8)				
Nominal output power	3000VA	3680VA	4000VA	5000VA	6000VA
Backup Rated current	13.2 a.c.A				
Backup Rated Apparent Power	3000VA				
Ingress Protection	IP 65				
Protective Class	Class I				
Operating temperature range	-25 ~ +60°C				









Copy of marking plate(representative):

<b>SOFAR SOLAR Hybrid Inverter</b>	
<b>Model No.</b>	<b>HYD 3600-ES</b>
Max.DC Input Voltage	600V
Operating MPPT Voltage Range	90V-580V
MAX.PV Isc	2x15A
Battery Type	Lead-acid,Lithium-ion
Battery Voltage Range	42-58V
Max.Charging Current	65A
Max.Discharging Current	70A
Max.Charging&Discharging Power	3000VA
Nominal Grid Voltage	230Vac
Nominal Output Voltage	230Vac
Max.Output Current	16A
Nominal Grid Frequency	50/60Hz
Power Factor	1(adjustable+/-0.8)
Nominal Output Power	3680VA
Backup Rated Current	13.2A
Backup Rated Apparent Power	3000VA
Ingress Protection	IP65
Operating Temperature Range	-25-+60°C
Protective Class	Class I
Manufacturer: Shenzhen SOFARSOLAR Co., Ltd. Address:5/F, Building 4, Antongda Industrial Park, NO.1Luxian Avenue, Xin'an Street, Bao'an District, shenzhen City, Guangdong Province, P.R. China	
VDE0126-1-1, VDE-AR-N 4105, G83/2, EN50438, C10/11, ASA4777, RD1699, UTE C15-712-1	

<b>SOFAR SOLAR Hybrid Inverter</b>	
<b>Model No.</b>	<b>HYD 3000-ES</b>
Max.DC Input Voltage	600V
Operating MPPT Voltage Range	90V-580V
MAX.PV Isc	2x15A
Battery Type	Lead-acid,Lithium-ion
Battery Voltage Range	42-58V
Max.Charging Current	65A
Max.Discharging Current	70A
Max.Charging&Discharging Power	3000VA
Nominal Grid Voltage	230Vac
Nominal Output Voltage	230Vac
Max.Output Current	13.7A
Nominal Grid Frequency	50/60Hz
Power Factor	1(adjustable+/-0.8)
Nominal Output Power	3000VA
Backup Rated Current	13.2A
Backup Rated Apparent Power	3000VA
Ingress Protection	IP65
Operating Temperature Range	-25-+60°C
Protective Class	Class I
Manufacturer: Shenzhen SOFARSOLAR Co., Ltd. Address: 5/F, Building 4, Antongda Industrial Park, NO.1Luxian Avenue, Xin'an Street, Bao'an District, shenzhen City, Guangdong Province, P.R. China	
VDE0126-1-1, VDE-AR-N 4105, G83/2, EN50438, C10/11, ASA4777, RD1699, UTE C15-712-1	

<b>SOFAR SOLAR Hybrid Inverter</b>	
<b>Model No.</b>	<b>HYD 4000-ES</b>
Max.DC Input Voltage	600V
Operating MPPT Voltage Range	90V-580V
MAX.PV Isc	2x15A
Battery Type	Lead-acid,Lithium-ion
Battery Voltage Range	42-58V
Max.Charging Current	65A
Max.Discharging Current	70A
Max.Charging&Discharging Power	3000VA
Nominal Grid Voltage	230Vac
Nominal Output Voltage	230Vac
Max.Output Current	18.2A
Nominal Grid Frequency	50/60Hz
Power Factor	1(adjustable+/-0.8)
Nominal Output Power	4000VA
Backup Rated Current	13.2A
Backup Rated Apparent Power	3000VA
Ingress Protection	IP65
Operating Temperature Range	-25-+60°C
Protective Class	Class I
Manufacturer: Shenzhen SOFARSOLAR Co., Ltd. Address:5/F, Building 4, Antongda Industrial Park, NO.1Luxian Avenue, Xin'an Street, Bao'an District, shenzhen City, Guangdong Province, P.R. China	
VDE0126-1-1, VDE-AR-N 4105, G83/2, EN50438, C10/11, ASA4777, RD1699, UTE C15-712-1	

<b>SOFAR SOLAR Hybrid Inverter</b>	
<b>Model No.</b>	<b>HYD 5000-ES</b>
Max.DC Input Voltage	600V
Operating MPPT Voltage Range	90V-580V
MAX.PV Isc	2x15A
Battery Type	Lead-acid,Lithium-ion
Battery Voltage Range	42-58V
Max.Charging Current	65A
Max.Discharging Current	70A
Max.Charging&Discharging Power	3000VA
Nominal Grid Voltage	230Vac
Nominal Output Voltage	230Vac
Max.Output Current	22.8A
Nominal Grid Frequency	50/60Hz
Power Factor	1(adjustable+/-0.8)
Nominal Output Power	5000VA
Backup Rated Current	13.2A
Backup Rated Apparent Power	3000VA
Ingress Protection	IP65
Operating Temperature Range	-25-+60°C
Protective Class	Class I
Manufacturer: Shenzhen SOFARSOLAR Co., Ltd. Address: 5/F, Building 4, Antongda Industrial Park, NO.1Luxian Avenue, Xin'an Street, Bao'an District, shenzhen City, Guangdong Province, P.R. China	
VDE0126-1-1, VDE-AR-N 4105, G83/2, EN50438, C10/11, ASA4777, RD1699, UTE C15-712-1	

<b>SOFAR SOLAR</b> Hybrid Inverter	
Model No.	<b>HYD 6000-ES</b>
Max.DC Input Voltage	600V
Operating MPPT Voltage Range	90V-580V
MAX.PV Isc	2x15A
Battery Type	Lead-acid,Lithium-ion
Battery Voltage Range	42-58V
Max.Charging Current	65A
Max.Discharging Current	70A
Max.Charging&Discharging Power	3000VA
Nominal Grid Voltage	230Vac
Nominal Output Voltage	230Vac
Max.Output Current	27.3A
Nominal Grid Frequency	50/60Hz
Power Factor	1(adjustable+/-0.8)
Nominal Output Power	6000VA
Backup Rated Current	13.2A
Backup Rated Apparent Power	3000VA
Ingress Protection	IP65
Operating Temperature Range	-25-+60°C
Protective Class	Class I
Manufacturer: Shenzhen SOFARSOLAR Co., Ltd. Address:5/F,Building 4,Antongda Industrial Park,NO.1Liuxian Avenue,Xin'an Street, Bao'an District,shenzhen City,Guangdong Province,P.R.China	
 VDE0126-1-1,VDE-AR-N 4105,G83/2,EN50438,C10/11, ASA4777,RD1699,UTE C15-712-1	
       	

DRM 0	<input checked="" type="checkbox"/>	DRM 1	<input type="checkbox"/>	DRM 2	<input type="checkbox"/>
DRM 3	<input type="checkbox"/>	DRM 4	<input type="checkbox"/>	DRM 5	<input type="checkbox"/>
DRM 6	<input type="checkbox"/>	DRM 7	<input type="checkbox"/>	DRM 8	<input type="checkbox"/>

**Note:**

1. The above markings are the minimum requirements required by the safety standard. For the final production samples, the additional markings which do not give rise to misunderstanding may be added.
2. Label is attached on the side surface of enclosure and visible after installation

AS/NZS 4777.2			
Clause	Requirement - Test	Result - Remark	Verdict
5	<b>GENERAL REQUIREMENTS</b>		P
5.1	<b>Electrical safety</b>		P
	Inverters for use in inverter energy systems with photovoltaic (PV) arrays shall comply with the appropriate electrical safety requirements of IEC 62109-1 and IEC 62109-2, and the requirements within this Standard.	Considered	P
	Inverters for use in inverter energy systems that have energy storage (batteries) as the only possible energy source shall comply with the electrical safety requirements of AS 62040.1.1, and the requirements within this Standard.		N/A
	Inverters for use in inverter energy systems that incorporate energy sources other than photovoltaic (PV) arrays or batteries shall comply with the applicable electrical safety requirements of IEC 62109-1 and IEC 62109-2, and the requirements within this Standard. However, for energy source inputs other than PV arrays or batteries, the requirements of IEC 62109-1 and IEC 62109-2 shall be applied with consideration of the inverter topology, the energy source voltage, installation requirements and potential faults which could present a hazard.	Considered	P
5.2	Provision for external connections		P
	Inverters shall be used and installed as fixed equipment only. Inverters shall not be used as portable equipment.		P
	Inverter provisions for external connection—		P
	(a) shall be for fixed equipment only; and	Fixed equipment only	P
	(b) shall provide for safe and reliable connection to any d.c. source or load or any a.c. source or load.		P
	All inverter ports (except communications ports) shall incorporate connection types for either—		P
	(i) permanently connected equipment; or		P
	(ii) pluggable type B equipment.		N/A
	Inverter source or load connections shall not incorporate connection types for pluggable type A equipment.		P
	Permanently connected inverters shall have suitable terminals for connection to fixed installation wiring.		P
	Pluggable type B equipment shall have one of the following means of connection:		N/A
	(A) A non-detachable cord for connection to the supply by means of a connector.		N/A
	(B) An appliance inlet suitable for connection to a matching connector.		N/A
	Pluggable type B equipment shall not incorporate—		N/A



AS/NZS 4777.2			
Clause	Requirement - Test	Result - Remark	Verdict
	(1) a connection by a connector or inlet complying with any of the dimensional sheets of AS/NZS 60320.1;		N/A
	(2) a connection by a plug conforming to AS/NZS 3112; or		N/A
	(3) a connection by a connector or inlet where hazardous voltages are accessible by the standard test finger.		N/A
5.3	Photovoltaic (PV) array earth fault/earth leakage detection		P
	For inverter energy systems used with PV array systems that require earth fault detection and a residual current detection, either internal or external to the inverter, the type of detection used shall be declared in accordance with IEC 62109-1 and IEC 62109-2.	PV and battery input	P
	If an external residual current device (RCD) is required, the manufacturer's installation instructions shall state the need for an RCD and shall specify its rating, type and required circuit location in accordance with Clause 9.	Internal RCM	N/A
	Compliance shall be checked by inspection of the inverter's markings and manufacturer's documentation, and testing in accordance with IEC 62109-2.		P
	Where the additional detection for functionally earthed PV arrays, as required by AS/NZS 5033, is present in the inverter, this additional detection shall, before start-up of the system—		N/A
	(a) open circuit the functional earth connection to the PV array;		N/A
	(b) measure the resistance to earth of each conductor of the PV array;		N/A
	If the earth resistance is above the resistance limit ( $R_{iso}$ limit) threshold specified in Table 1, the system shall reconnect the functional earth and shall be allowed to start; and		N/A
	(d) if the earth resistance is equal to or less than the resistance limit ( $R_{iso}$ limit) threshold specified in Table 1, the inverter shall shut down and initiate an earth fault alarm in accordance with the requirements of IEC 62109-2.		N/A
5.4	Compatibility with electrical installation		P
	The inverter shall be compatible with wiring practices for LV electrical installations of AS/NZS 3000 and variations as required in AS/NZS 4777.1. The inverter a.c. voltage and frequency operation shall comply with the limits specified in AS 60038 (for Australia), or IEC 60038 (for New Zealand).		P
5.5	Power factor		P



AS/NZS 4777.2			
Clause	Requirement - Test	Result - Remark	Verdict
	The displacement power factor of the inverter, considered as a load from the perspective of the grid, shall, for all current outputs from 25% to 100% of rated current, operate at unity power factor within the range 0.95 leading to 0.95 lagging.	See appended table	P
	NOTE: For all inverter current outputs below 25% of rated current, it is acceptable for the displacement power factor to be controlled such that the vars supplied or drawn are less than the amount of vars supplied or drawn at 25% current output.		P
	Operation at power factor other than unity is acceptable where the inverter operates in power quality response modes. Additional requirements for displacement power factor control apply for inverters that are capable of operating in power quality response modes. See Clause 6.3.		P
	Compliance shall be determined by type testing in accordance with the power factor test specified in Appendix B.	See appended table	P
5.6	Harmonic currents		P
	The harmonic currents of the inverter shall not exceed the limits specified in Tables 2 and 3 and the total harmonic current distortion (ITHD) to the 50 <sup>th</sup> harmonic shall be less than 5%.		P
	Compliance shall be determined by type testing in accordance with the harmonic current limit test specified in Appendix C.	See appended table	P
5.7	Voltage fluctuations and flicker		P
	The inverter shall conform to the voltage fluctuation and flicker limits specified in AS/NZS 61000.3.3 for equipment with rated current less than or equal to 16 A per phase (a.c.).		P
	For equipment with rated current greater than 16 A per phase (a.c.), if the inverter cannot meet the requirements of AS/NZS 61000.3.3, the maximum permissible connection point impedance ( $Z_{max}$ ) shall be determined such that the voltage fluctuation and flicker limits specified in AS/NZS 61000.3.3 can be met. The impedance shall be determined in accordance with the methods given in AS/NZS 61000.3.11. The values of $P_{st}$ and $P_{lt}$ , when tested using $Z_{ref}$ , and the network impedance value ( $Z_{max}$ or $Z_{ref}$ ) required for compliance shall be included in the inverter documentation.		P
	Compliance shall be determined by testing in accordance with the appropriate Standard. The inverter shall remain connected throughout the test and the automatic disconnection device shall not operate.	See appended table	P
5.8	Transient voltage limits		P

AS/NZS 4777.2			
Clause	Requirement - Test	Result - Remark	Verdict
	To prevent damage to electrical equipment connected to the same circuit as the inverter, disconnection of the inverter from the grid shall not result in transient overvoltages beyond the limits specified in Table 4.		P
	Compliance shall be determined by type testing in accordance with the transient voltage limit test specified in Appendix D. The voltage-duration curve is derived from the measurements taken at the grid-interactive port of the inverter.	See appended table	P
5.9	Direct current injection		P
	In the case of a single-phase inverter, the d.c. output current of the inverter at any a.c. port including the grid-interactive and/or stand-alone port shall not exceed 0.5% of the inverter's rated current or 5 mA, whichever is the greater.		P
	In the case of a three-phase inverter, the d.c. output current of the inverter at any a.c. port, including the grid-interactive and/or stand-alone port, measured in each of the phases, shall not exceed 0.5% of the inverter's per-phase rated current or 5 mA, whichever is the greater.		N/A
	If the inverter does not incorporate a mains frequency isolating transformer or is not used with a dedicated external isolation transformer, it shall be type tested to ensure the d.c. output current at any a.c. port of the inverter is below the limits specified above at all output current levels.		P
	Compliance shall be determined by type testing in accordance with the d.c. current injection test specified in Appendix E.	See appended table	P
5.10	Current balance for three-phase inverters		N/A
	In the case of a three-phase inverter the a.c. output current shall be generated and injected into the three-phase electrical installation as a three-phase balanced current.	Single-phase inverter	N/A
	Compliance shall be determined by type testing in accordance with the following requirement. The a.c. output current for each phase for three-phase balanced current shall be within 5% of the measured value of the other phases at rated current when injected into a balanced three phase voltage.		N/A
	Inverters which can be used in a voltage balance mode, as defined in Clause 6.3.2.4, are allowed to generate unbalanced currents.		N/A
6	OPERATIONAL MODES AND MULTIPLE MODE INVERTERS		P
6.1	General		P
	Unless otherwise stated, the modes in the following Clauses are for the grid-interactive port of the		P

AS/NZS 4777.2			
Clause	Requirement - Test	Result - Remark	Verdict
	inverter.		
6.2	Inverter demand response modes (DRMs)		P
6.2.1	General		P
	The inverter shall support the demand response mode DRM 0 of Table 5. The inverter should support the other demand response modes of Table 5.		P
	The inverter shall detect and initiate a response to all supported demand response commands within 2 s. The inverter shall continue to respond while the mode remains asserted.		P
	The inverter shall comply with the relevant requirements of Clause 5 and this Clause (6), and with all of the requirements of Clause 7, while any demand response mode is asserted.		P
	Compliance shall be determined by testing as specified in Appendix I.	See appended table	P
6.2.2	Interaction with demand response enabling device (DRED)		P
	The inverter shall have a means of connecting to a DRED. This means of connection shall include a terminal block or RJ45 socket. The terminal block or RJ45 socket shall comply with the minimum electrical specifications in Table 6. The terminal block or RJ45 socket may be physically mounted in the inverter or in a separate device that remotely communicates with the inverter.	RJ45 used	P
	The DRED asserts demand response modes by shorting together terminals or pins as specified in Table 7. In detecting the state of the DRED, the inverter shall comply with the following requirements:		P
	(a) The inverter shall not inject more than 30 mA (d.c. or a.c.) into—	DRM0	N/A
	(i) terminals 'DRM1/5', 'DRM2/6', 'DRM3/7' or 'DRM4/8', where a terminal block is used; or	DRM0	N/A
	(ii) pins 1, 2, 3 or 4, where an RJ45 socket is used.	DRM0	N/A
	(b) The inverter shall allow for a drop of up to 1.6 V across the DRED and associated wiring when nominally shorted.	DRM0	N/A
	(c) The inverter shall not supply more than 34.5 V (d.c. or a.c.) to any terminal of the terminal block or RJ45 socket.		P
	(d) If the impedance between pins 5 and 6 is detected to be above 20 k $\Omega$ , the inverter shall fail-safe to DRM 0 asserted.		P

AS/NZS 4777.2			
Clause	Requirement - Test	Result - Remark	Verdict
	The DRED may assert more than one DRM at a time, in which case the requirements of every active DRM that is supported by the inverter shall be simultaneously satisfied.	DRM0	N/A
	The inverter shall detect the assertion of any combination of DRMs which result in terminal 5 and 6 being shorted simultaneously as assertion of DRM 0.		P
	Where DRM 3 or DRM 7 are supported, the reactive power set-point shall be set by default to operate at unity power factor. The reactive power set-point should be adjustable up to a minimum of 60% of the inverter's kVA rating.	DRM0	N/A
	The inverter may optionally provide a power supply for use by the DRED. If included this shall be d.c. and of a voltage less than 34.5 V.	No power supply provide	N/A
	Where an RJ45 socket is used, pins 7 and 8 may be utilized as positive and negative DRED power supply pins respectively. The power supply shall be capable of delivering at least 0.5 A at a minimum of 6 V d.c., otherwise the inverter shall short pins 7 and 8 together.		N/A
	Where a terminal block is used, only those terminals needed for the supported DRMs are required.		N/A
6.3	Inverter power quality response modes		P
6.3.1	General		P
	The inverter may have the capability of operating in modes which will—		P
	(a) contribute to maintaining the power quality at the point of connection with the customer installation; or		P
	(b) provide characteristics which are outside the typical operation of an inverter for the purpose of providing support to a grid.		P
	These various operating modes may be enabled or disabled in an inverter and may include the following:		P
	(i) Volt response modes.		P
	(ii) Fixed power factor or reactive power mode.		P
	(iii) Power response mode.		P
	(iv) Power rate limit.		P
	If these power quality response modes are available in the inverter, the inverter shall comply with the relevant requirements of this Clause (6) and Clause 5, and all of the requirements of Clauses 7 and 8, when these modes are enabled or disabled.		P
	Compliance shall be determined by type testing as specified in Appendix I with the applicable modes disabled and enabled.		P

AS/NZS 4777.2			
Clause	Requirement - Test	Result - Remark	Verdict
	If these power quality response modes of operation are controlled by an external device, the external device shall not interfere with the inverter complying with the relevant requirements of this Clause (6) and Clause 5, and all of the requirements of Clauses 7 and 8, when the external device is controlling these modes.		N/A
6.3.2	Volt response modes		P
6.3.2.1	General		P
	The intent of including the volt response modes, which respond to voltage changes at the inverter terminals, is to increase the number of systems which can be connected at a point on the grid without adversely affecting the voltage within an electrical installation.		P
	The volt - watt and volt - var response modes specified in Clause 6.3.2.2 and Clause 6.3.2.3 shall use the volt response reference values specified in Table 9. Each volt response mode may have volt response reference values which are independent of other volt response modes. This is to allow different volt response curves for different volt response modes.		P
6.3.2.2	Volt - watt response mode		P
	The volt - watt response mode varies the output power of the inverter in response to the voltage at its terminal. The inverter should have the volt - watt response mode. If this mode is available, it shall be enabled by default.	See appended table	P
	The response curve required for the volt - watt response mode is defined by the volt response reference values in Table 9 and corresponding power levels. The default values are listed in Table 10 and example response modes are shown in Figure 2(A) for Australia and Figure 2(B) for New Zealand.		P
6.3.2.3	Volt - var response mode		P
	The volt - var response mode varies the reactive power output of the inverter in response to the voltage at its grid-interactive port. The inverter should have the volt - var response capability. If this mode is available, it shall be disabled by default.	See appended table	P
	The response curve required for the volt - var response is defined by the volt response reference values specified in Table 9 and corresponding var levels. The default values are listed in Table 11 and shown in Figure 3.		P
6.3.2.4	Voltage balance modes		N/A
	If the voltage balance mode is available, the following requirements apply:		N/A

AS/NZS 4777.2			
Clause	Requirement - Test	Result - Remark	Verdict
	(a) The voltage balance mode shall be disabled by default.		N/A
	(b) For single-phase inverters used in a three-phase combination, the requirements of Clause 8.2 apply.		N/A
	I The voltage balancing mode shall be able to—		N/A
	(i) operate correctly with a single fault applied;		N/A
	(ii) detect the fault or loss of operability and cause the inverter to revert to injecting current into the three-phase electrical installation as a three-phase balanced current; or		N/A
	(iii) detect the fault or loss of operability and disconnect the inverter from the electrical installation.		N/A
6.3.3	Fixed power factor mode and reactive power mode		P
	The fixed power factor mode and the reactive power mode may be required in some situations by the electrical distributor to meet local grid requirements. These modes shall be disabled by default.	See appended table	P
	If the inverter is capable of operating with reactive power mode, the maximum ratio of reactive power (vars) to rated apparent power should be 100%. The reactive power modes may be required to be fixed at a constant reactive power by the electrical distributor.		P
	If the inverter is capable of operating with fixed power factor mode, the minimum range of settings should be 0.8 leading to 0.8 lagging. The fixed power factor mode is for control of the displacement power factor over the range of inverter power output.		P
6.3.4	Characteristic power factor curve for $\cos \phi$ (P) (Power response)		P
	The characteristic power factor curve for $\cos \phi$ (P) (Power response) mode varies the displacement power factor of the output of the inverter in response to changes in the output power of the inverter, i.e. $\cos \phi$ (P) modes. If this mode is available, it shall be disabled by default.	See appended table	P
	The response curve required for the $\cos \phi$ (P) response should be defined within displacement power factor range of 0.9 leading to 0.9 lagging. One possible $\cos \phi$ (P) curve is shown in Figure 4.		P
6.3.5	Power rate limit		P
6.3.5.1	General		P

AS/NZS 4777.2			
Clause	Requirement - Test	Result - Remark	Verdict
	The power rate limit for an inverter is a power quality response mode. The inverter shall have the capability to rate limit changes in power generation through the grid-interactive port. Inverters capable of multiple mode operation should have the capability to rate limit changes in power consumption (for example increasing/decreasing of charging rates of connected energy storage).	See appended table	P
	The power rate limit only applies to the changes specified in Clause 6.3.5.3.		P
	The power rate limit does not apply when the inverter disconnection device is required to operate (i.e. to disconnect).		P
6.3.5.2	Gradient of power rate limit		P
	The power rate limit ( $W_{Gra}$ ) is the ramp rate of real power output in response to changes in power and is defined as a percentage of rated power per minute. The nominal ramp time ( $T_n$ ) is the nominal time for a 100% change in output power with a power rate limit of $W_{Gra}$ . An inverter shall have an adjustable power rate limit ( $W_{Gra}$ ) which limits the change in power output to the set power rate limit. The default setting for the power rate limit ( $W_{Gra}$ ) for increase and decrease shall be 16.67% of rated power per minute which is a nominal ramp time of 6 min.		P
	The power rate limit ( $W_{Gra}$ ) shall be adjustable within the range 5% to 100% of rated power per minute. It is acceptable to have two separate power rate limits for increase and decrease in output power, as follows:		P
	(a) To rate limit an increase in power ( $W_{Gra+}$ ).		P
	(b) To rate limit a decrease in power ( $W_{Gra-}$ ).		N/A
6.3.5.3	Power rate limit modes		P
6.3.5.3.1	General		P
	The inverter power rate limit ( $W_{Gra}$ ) is applicable to operate in the following modes:		P
	(a) Soft ramp up after connect or reconnect.		P
	(b) Changes in a.c. operation and control.		N/A
	(c) Changes in energy source operation.		P
6.3.5.3.2	Soft ramp up after connect or reconnect		P
	All inverters shall have this mode. This mode shall be enabled as per Clause 7.7 and for the increase in power required by Clause 7.5.3 after frequency decreased to the required limit.		P
6.3.5.3.3	Changes in a.c. operation and control	DRM0	N/A



AS/NZS 4777.2			
Clause	Requirement - Test	Result - Remark	Verdict
	If available, this mode shall be enabled for a change in a demand response mode of Clause 6.2 (except for DRM 0). When a demand response mode of Clause 6.2 (except for DRM 0) is asserted or unasserted the power rate limit ( $W_{Gra}$ ) shall apply to the increase or decrease in power generation or consumption and the transitions between power output levels.		N/A
	The power rate limit for changes in a.c. operation and control does not apply to those inverters that are correcting for sags and swells of less than 1 min.		N/A
6.3.5.3.4	Changes in energy source operation		P
	This mode only applies to multiple mode inverters with energy storage. It operates when there is a change in the energy resource available to the inverter, which causes a change in output through the grid-interactive port. For this mode the power rate limit ( $W_{Gra}$ ) should apply to the increase or decrease in power generation or consumption, and to the transitions between power output levels. For this mode, the power rate limit ( $W_{Gra}$ ) should be able to be enabled or disabled. The power rate limit shall be disabled by default. The increase or decrease for transitions between power output levels is contingent on external situations (such as amount of available solar energy, wind energy or discharge capacity). Only for increases or decreases in the output which are faster than the power rate limit ( $W_{Gra}$ ) does a control action to limit the ramp rate apply.		P
6.3.5.4	Nonlinearity of power rate limit changes		P
	The nonlinearity (NL) of the power rate limit ( $W_{gra}$ ) in response to an increase of the inverter power output, as defined by the characteristic curve depicted in Figure 5, shall be less than 10%.		P
6.4	Multiple mode inverter operation		P
6.4.1	General		P
	The requirements in this Clause for multiple mode inverters are in addition to the requirements for inverters.		P
	When the multiple mode inverter is disconnected from the grid any stand-alone port shall ensure that all active conductors are also isolated from the grid-interactive port.		P
	Multiple mode inverters shall be arranged to ensure that the continuity of the neutral conductor to the load from the electrical installation is not interrupted when the inverter disconnects from the grid and supplies a load via the stand-alone port.		P
	Multiple mode inverters shall be arranged such that only the allowed installation methods of AS/NZS 3000 and AS/NZS 4777.1 can be used.		P

AS/NZS 4777.2			
Clause	Requirement - Test	Result - Remark	Verdict
	When the multiple mode inverter is providing the stand-alone function and is disconnected from the grid, the stand-alone port shall comply with the requirements for d.c. current injection (refer to Clause 5.9) into the connected load circuits. The type of RCD compatible with and for use on the stand-alone function outputs shall be declared.		P
6.4.2	Sinusoidal output in stand-alone mode		P
	The a.c. output voltage waveform of a stand-alone port of a multiple mode inverter operating in stand-alone mode, shall comply with the requirements of this Clause (6.4.2). The a.c. output voltage waveform of a stand-alone mode shall have a voltage total harmonic distortion (THD) not exceeding of 5% and no individual harmonic at a level exceeding 5%.		P
	Compliance shall be checked by measuring the THD and the individual harmonic voltages with the inverter delivering 5% power or the lowest continuous available output power greater than 5%, and 50% and 100% of its continuous rated power, into a resistive load, with the inverter supplied with nominal d.c. input voltage. The THD measuring instrument shall measure the sum of the harmonics from $n = 2$ to $n = 50$ as a percentage of the fundamental ( $n = 1$ ) component at each load level.		P
6.4.3	Volt - watt response mode for charging of energy storage		P
	The volt - watt response mode for charging of energy storage varies the power input of the inverter from the grid in response to the voltage at its grid-interactive port. A multiple mode inverter with energy storage which can be charged from the grid shall have this volt - watt response mode. This volt - watt response mode is only active when power from the grid is required to charge the energy storage.		P
	The response curve required for the volt - watt response is defined by the volt response reference values in Table 9 and corresponding power consumption from the grid through the grid-interactive port for charging energy storage. The default values are listed in Table 12 and shown in Figure 6.		P
6.5	Security of operational settings		P
	The internal settings of the demand response or power quality response modes of the inverter shall be secured against inadvertent or unauthorized tampering. Changes to the internal settings shall require the use of a tool and special instructions not provided to unauthorized personnel.		P
	The installer-accessible settings shall be capable of being adjusted within the values specified in this Clause (6).		P

AS/NZS 4777.2			
Clause	Requirement - Test	Result - Remark	Verdict
	Compliance shall be determined by inspection.		P
7	PROTECTIVE FUNCTIONS FOR CONNECTION TO ELECTRICAL INSTALLATIONS AND THE GRID		P
7.1	General		P
	There shall be an automatic disconnection device to prevent injection of energy into the point of supply and prevent the formation of an unintentional island with the grid or part thereof when supply is disrupted from the grid.	two relays in serial used as automatic disconnection means	P
7.2	Automatic disconnection device		P
	The automatic disconnection device shall prevent power (both a.c. and d.c.) from entering the grid when the automatic disconnection device operates.		P
	The automatic disconnection device shall provide isolation in all live conductors.		P
	Automatic disconnection devices for isolation shall comply with the following requirements:		P
	(a) They shall be capable of withstanding an impulse voltage likely to occur at the point of installation, or have an appropriate contact gap.	There are two relays in serial used as automatic disconnection means. Contact gap is >1.5 mm for each relay	P
	(b) They shall not be able to falsely indicate that the contacts are open.		P
	(c) They shall be designed and installed so as to prevent unintentional closure, such as might be caused by impact, vibration or the like.	Self-check before the inverter work	P
	(d) They shall be devices that disconnect all live conductors (active and neutral) of the inverter from the grid-interactive port.		P
	(e) They shall be such that with a single fault applied to the automatic disconnection device or to any other location in the inverter, at least basic insulation or simple separation is maintained between the energy source port and the grid-interactive port when the means of disconnection is intended to be in the open state.	There are two relays in serial used as automatic disconnection means.	P
	(f) They shall be such that with a single fault applied to the automatic disconnection device or to any other location in the inverter, power is prevented from entering the grid.	the inverter would shutdown and disconnect from grid	P
	The automatic disconnection device shall be capable of interrupting at least the rated current.		P
	The settings of the automatic disconnection device shall not exceed the capability of the inverter.		P
	A semiconductor (solid-state) device shall not be used for isolation purposes.	Not solid-state device	P

AS/NZS 4777.2			
Clause	Requirement - Test	Result - Remark	Verdict
7.3	Active anti-islanding protection		P
	The automatic disconnection device shall incorporate at least one method of active anti-islanding protection.		P
	The method used to provide active anti-islanding protection shall be declared.	frequency shift method used	P
	To prevent islanding, the active anti-islanding protection system shall operate the automatic disconnection device (see Clause 7.2) within 2 s of disruption to the power supply from the grid.		P
	Compliance shall be determined by type testing in accordance with the active anti-islanding tests specified in Appendix F or IEC 62116.	See appended table in accordance with IEC 62116	P
7.4	Voltage and frequency limits (passive anti-islanding protection)		P
	The automatic disconnection device shall incorporate the following forms of passive anti-islanding protection:		P
	(a) Undervoltage and overvoltage protection.		P
	(b) Under-frequency and over-frequency protection.		P
	For sustained variation of the voltage and frequency beyond each limit specified in Table 13, the automatic disconnection device (see Clause 7.2) shall operate no sooner than the required trip delay time and before the maximum disconnection time.		P
	This requires the inverter to remain in continuous, uninterrupted operation for voltage variations with a duration shorter than the trip delay time specified in Table 13.		P
	Each protective function limit shall be preset and secured against change.		P
	Compliance shall be determined by type testing in accordance with the voltage and frequency limits tests specified in Appendix G.	See appended table	P
7.5	Limits for sustained operation		P
7.5.1	General		P
	The inverter or inverter energy system shall remain connected over the range of voltages and frequencies that it is required to be compatible with. Refer to Clause 5.4.		P
7.5.2	Sustained operation for voltage variations		P
	The inverter shall operate the automatic disconnection device (see Clause 7.2) within 30 s when the average voltage for a 10 min period exceeds the $V_{nom\_max}$ , where $V_{nom\_max}$ lies in the range 244 - 258 V.		P
	The sustained operation for voltage variations shall not interfere with the active and passive anti-islanding requirements of Clauses 7.3 and 7.4.		P

AS/NZS 4777.2			
Clause	Requirement - Test	Result - Remark	Verdict
	The limit $V_{nom-max}$ , shall be preset to the default set-point and may be programmable up to the maximum 258 V. The default set-point for $V_{nom-max}$ shall be as follows:		P
	(a) In Australia: 255 V.		P
	(b) In New Zealand: 248 V.		P
	The 10 min average value shall be compared against the limit $V_{nom-max}$ at least every 3 s to determine when to disconnect.		P
	Compliance shall be determined by type testing in accordance with the sustained operation for voltage variations test specified in Appendix H.	See appended table	P
7.5.3	Sustained operation for frequency variations		P
7.5.3.1	Response to an increase in frequency		P
	The inverter shall be capable of supplying rated power between 47 Hz and 50.25 Hz for Australia.		P
	The inverter shall be capable of supplying rated power between 45 Hz and 50.25 Hz for New Zealand.		P
	When a grid frequency disturbance results in an increase in grid frequency which exceeds 50.25 Hz, the inverter shall reduce the power output linearly with an increase of frequency until $f_{stop}$ is reached, where $f_{stop}$ lies in the range 51 – 52 Hz.		P
	The power level present at the time the frequency reaches or exceeds 50.25 Hz shall be held as the reference power level used to calculate the required response to the increasing frequency.		P
	When the frequency exceeds $f_{stop}$ the inverter power output shall be ceased (i.e. 0 W). The default set-point for $f_{stop}$ shall be 52 Hz.		P
	The output power shall remain at or below the lowest power level reached in response to an over-frequency event between 50.25 Hz and $f_{stop}$ . This is to provide hysteresis in the control of the inverter. When the grid frequency has decreased back to 50.15 Hz or less for at least 60 s, the power level shall be increased at a rate no greater than the power rate limit ( $W_{Gra}$ ) of Clause 6.3.5 until the available energy source power is reached. Figure 7(A) shows this.		P
	Unconstrained power operation may recommence 6 min after the frequency returns to and remains at less than 50.15 Hz.		P
	Compliance shall be determined by type testing in accordance with the sustained operation for frequency variations test specified in Appendix H.	See appended table	P
7.5.3.2	Response to a decrease in grid frequency		P
	This requirement applies only to inverters with energy storage.		P

AS/NZS 4777.2			
Clause	Requirement - Test	Result - Remark	Verdict
	The inverter shall be capable of charging the energy storage between 49.75 Hz and 52.0 Hz.		P
	When a grid frequency disturbance results in a decrease in grid frequency which falls below 49.75 Hz, an inverter with energy storage which is charging from the grid port should reduce the power input for charging linearly with a decrease of frequency until $f_{\text{stop-CH}}$ is reached, where $f_{\text{stop-CH}}$ lies in the range 47 – 49 Hz.		P
	The power input level for charging present at the time the frequency reaches or falls below 49.75 Hz shall be held as the reference charge rate used to calculate the required response to the decreasing frequency.		P
	When the frequency falls below $f_{\text{stop-CH}}$ , the inverter should have ceased charging the storage element (i.e. 0 W). The default set-point for $f_{\text{stop-CH}}$ should be 49 Hz.		P
	The power input level for charging of the storage element shall remain at or below the lowest charge rate reached in response to a low-frequency event between $f_{\text{stop-CH}}$ and 49.75 Hz. This is to provide hysteresis in the control of the inverter.		P
	When the grid frequency has increased back to 49.85 Hz or more for at least 60 s, the charge rate of the storage element may be increased at a rate no greater than the power rate limit ( $W_{\text{Gra}}$ ) of Clause 6.3.5 until the charge rate present at the time of the frequency disturbance is reached. Figure 7(B) shows this.		P
	Unconstrained charging of the storage element may recommence 6 min after the frequency returns to and remains above than 49.85 Hz.		P
	Compliance shall be determined by type testing in accordance with the sustained operation for frequency variations test specified in Appendix H.		P
7.6	Disconnection on external signal		P
	The automatic disconnection device shall incorporate the ability to disconnect on an external signal.		P
	If an external signal or demand response 'DRM 0' condition is asserted, the automatic disconnection device shall operate within 2 s.		P
	Compliance shall be determined by type testing as specified in Appendix I.	See appended table	P
7.7	Connection and reconnection procedure		P
	Only after all of the following conditions have been met shall the automatic disconnection device operate to connect or reconnect the inverter to the grid—		P
	(a) the voltage of the grid has been maintained within the limits of AS 60038 (for Australia) or IEC 60038 (for New Zealand) for at least 60 s;		P

AS/NZS 4777.2			
Clause	Requirement - Test	Result - Remark	Verdict
	(b) the frequency of the grid has been maintained within the range 47.5 Hz to 50.15 Hz for at least 60 s;		P
	(c) the inverter and the grid are synchronized and in-phase with each other; and		P
	(d) no external signal is present or DRM 0 asserted requiring the system to be disconnected.		P
	After the automatic disconnection device operates to connect or reconnect the inverter the output shall rate limit increase in power generation to the set power rate limit ( $W_{Gra}$ ) for increase in power of Clause 6.3.5. Unconstrained power operation may recommence after the automatic disconnection device operates to connect or reconnect the inverter, when either the rated power output is reached or the required output power level of the inverter exceeds the available energy source.		P
	Compliance shall be determined by type testing in accordance with the tests as specified in Appendix F and Appendix G.	See appended table	P
7.8	Security of protection settings		P
	The internal settings of the automatic disconnection device shall be secured against inadvertent or unauthorized tampering. Changes to the internal settings shall require the use of a tool and special instructions not provided to unauthorized personnel.		P
	The installer-accessible settings of the automatic disconnection device shall be capable of being adjusted within the limits specified in Clause 7.5.		P
	The manufacturer settings of the automatic disconnection device, specified in Clause 7.4, shall be secured against changes.		P
	Compliance shall be determined by inspection.		P
8	MULTIPLE INVERTER COMBINATIONS		N/A
8.1	General		N/A
	There are installations where multiple inverter energy systems are used and the electrical installation connects at a single point of supply to the grid. Inverter energy systems are often comprised of multiple inverters used in combination to provide the desired inverter energy system capacity or to ensure that voltage balance is maintained in multiple phase connections to the grid.	No in such used	N/A
	This Clause (8) specifies the requirements and tests for inverter energy systems used in such combinations. If a combination is not tested, it should not be used or external devices should be used in accordance with the requirements of AS/NZS 4777.1.		N/A



AS/NZS 4777.2			
Clause	Requirement - Test	Result - Remark	Verdict
	Possible combinations are single-phase inverters used in parallel, single-phase inverters used in multiple phase installations and three-phase inverters used in parallel.		N/A
8.2	Inverter current balance across multiple phases		N/A
	In a three-phase inverter system comprised of individual single-phase inverters the a.c. output current should be generated and injected into the three-phase electrical installation as a three-phase balanced current. The maximum current imbalance in a three-phase inverter system comprised of individual single-phase inverters shall be no more than 21.7 A.		N/A
8.3	Grid disconnection		N/A
	When any inverter within the inverter energy system disconnects as required by Clause 7, all inverters within the inverter energy system shall disconnect within 2 s of the first inverter disconnecting. This applies to all inverters used in combination for single-phase or multiple phases.		N/A
8.4	Grid connection and reconnection		N/A
	When multiple inverters are used together in a multiple phase combination, only after all the conditions of Clause 7.7 have been met on all connected phases shall the automatic disconnection device operate to connect or reconnect any inverter of the multiple phase combination to the grid.		N/A
	Where any inverter used in a multiple phase combination has a rated current exceeding 21.7 A per phase, the requirement of Clause 8.2 shall be met when connecting or reconnecting.		N/A
8.5	Testing combinations		N/A
8.5.1	Single-phase combinations		N/A
	Single-phase parallel combinations of inverters shall be tested for combinations with total rated current ( $I_{rated}$ ) equal to or up to the maximum of 6 A per phase.		N/A
	To determine the number of inverters to be tested, the following equation shall be used: $N = 6/I_{rated}$		N/A
	If $N \geq 2$ , the minimum number of inverters to be tested shall be N. If $N > 6$ , the maximum number of inverters to be tested in a combination shall be 6.		N/A
8.5.2	Single-phase inverters used in three-phase combinations		N/A
	For single-phase inverters with rated current ( $I_{rated}$ ) greater than or equal to 5 A used in three-phase combinations, three inverters shall be tested in a three-phase arrangement [refer to Figure 8(a)].		N/A
	Single-phase inverters with rated current less than 5 A and to be used in three-phase combinations shall be tested in combination with at least two inverters per phase [refer to Figure 8(b)].		N/A

AS/NZS 4777.2			
Clause	Requirement - Test	Result - Remark	Verdict
8.5.3	Required tests for multiple inverter combinations		N/A
	Any single-phase inverter used in a multiple inverter combination shall be tested individually and meet all the requirements of this Standard. Any single-phase inverter which is to be used as part of a multiple inverter combination shall be tested in combination as specified in Clauses 8.5.1 and 8.5.2.		N/A
	The tests specified in Table 14 for multiple inverter combinations shall be performed.		N/A
	Compliance shall be determined by type testing as specified in Appendix J.		N/A
8.5.4	Multiple inverters with one automatic disconnection device		N/A
	Where the inverter does not have an internal automatic disconnection device, or requires an external automatic disconnection device to provide the required disconnection function, or both, testing shall be conducted with the automatic disconnection device and with either the number of inverters required by Clause 8.5.1 and 8.5.2 or with the automatic disconnection device configured with the number of inverters specified by the manufacturer 's instructions.		N/A
	Compliance shall be determined by performing all of the type tests specified in Clause 5.		N/A
9	INVERTER MARKING AND DOCUMENTATION		P
9.1	General		P
	The inverter shall comply with the marking and documentation requirements of IEC 62109-1 and IEC 62109-2, as varied by this Clause (9).		P
	All markings and documentation shall be in the English language.		P
9.2	Marking		P
9.2.1	General		P
	The following variations apply to the marking requirements of IEC 62109-1 and IEC 62109-2:		P
	(a) Inverters that are designated for use in inverter energy systems incorporating energy sources other than PV arrays or batteries shall bear additional or alternative markings appropriate to the energy source.		N/A
	(b) Inverters that are designated for use in closed electrical operating areas shall be marked with a warning stating that they are not suitable for installation in households or areas of a similar type or use (i.e. domestic).		N/A
9.2.2	Equipment ratings		P

AS/NZS 4777.2			
Clause	Requirement - Test	Result - Remark	Verdict
	The inverter shall be marked with its ratings and the ratings of each port, as specified in Table 15. Only those ratings that are applicable to the type of inverter are required. The ratings shall be plainly and permanently marked on the inverter, in a location that is clearly visible after installation.		P
9.2.3	Ports		P
	Each port shall be marked with its classification and indicate whether a.c or d.c. voltage as appropriate.		P
	Typical classifications include the following:		P
	(a) PV (photovoltaic).		P
	(b) Wind turbine.		N/A
	(c) Energy storage.		N/A
	(d) Battery.		P
	(e) Generator.		N/A
	(f) Grid-interactive.		P
	(g) Stand-alone.		P
	(h) Communications (type).		P
	(i) DRM.		P
	(j) Load.		P
9.2.4	External and ancillary equipment		N/A
	If the inverter requires external or ancillary equipment for compliance with this Standard, the requirement for any such equipment shall be marked on the inverter along with the following or an equivalent statement: 'Refer to the installation instructions for type and ratings' or symbol.		N/A
	Any external or ancillary equipment shall be marked in accordance with this Clause (9).		N/A
9.2.5	Residual current devices (RCDs)		N/A
	Inverter energy systems used with PV array systems require residual current detection in accordance with IEC 62109-1 and IEC 62109-2. The requirements can be met by the installation of a suitably rated RCD external to the inverter or by an RCMU integral to the inverter.		N/A
	Where an external RCD is required, the inverter shall be marked with a warning along with the rating and type of RCD required. The warning shall be located in a prominent position and written in lettering at least 5 mm high. It shall contain the following or an equivalent statement:		N/A
	WARNING: AN RCD IS REQUIRED ON THE [NAME] PORTS OF THE INVERTER		N/A

AS/NZS 4777.2			
Clause	Requirement - Test	Result - Remark	Verdict
	If the inverter energy system requires a Type B RCD, the inverter shall be marked with a warning. The warning shall be located in a prominent position and written in lettering at least 5 mm high. It shall contain the following:		N/A
	WARNING: A TYPE B RCD IS REQUIRED ON THE [NAME] PORTS OF THE INVERTER		N/A
9.2.6	Demand response modes		P
	The demand response modes supported by the inverter should be permanently marked on the name plate or on a durable sticker located on or near the demand response interface port to indicate the demand response modes of which the unit is capable.	DRM 0	P
	Figure 9 illustrates an acceptable form of marking. If this form of marking is used, each box shall contain a tick or a cross (if the inverter has that capability) or remain blank (if it does not have that capability). Alternatively, only the modes supported may be marked.		P
	If the physical interface is a terminal block, then—	RJ45 used	N/A
	(a) the terminals shall be engraved or otherwise durably marked; or		N/A
	(b) a permanent label with ‘DRM Port’ shall be affixed near the terminal block.		N/A
	The marking shall indicate which terminal corresponds to which demand response mode.		N/A
	The range of markings is indicated against Pins 1 to 6 in Table 7.		N/A
9.3	Documentation		P
9.3.1	General		P
	The documentation supplied with the inverter shall provide all information necessary for the correct installation, operation and use of the system and any required external devices including information specified in Clause 9.2.		P
	All inverters, including those intended for use in systems incorporating energy sources other than PV arrays or batteries, shall comply with the documentation requirements of IEC 62109-1 and IEC 62109-2.		P
9.3.2	Equipment ratings		P
	The documentation supplied with the inverter shall state the ratings of the inverter and the ratings for each port, as specified in Table 16. Only those ratings that are applicable to the type of inverter are required.		P
	For equipment with rated current greater than 16 A per phase, additional documentation requirements apply. See Clause 5.7.		P
9.3.3	Ports		P

AS/NZS 4777.2			
Clause	Requirement - Test	Result - Remark	Verdict
	In addition to the requirements of Clause 9.3.2, the documentation supplied with the inverter shall state the following for each port, as a minimum:		P
	(a) Means of connection.		P
	(b) For pluggable equipment type B, the type of matching connectors to be used.		N/A
	(c) External controls and protection requirements.		P
	(d) Explanation of terminals or pins used for connection including polarity and voltage.		P
	(e) Tightening torque to be applied to terminals.		P
	(f) Instructions for protective earthing.		P
	(g) Instructions for connection of loads and installation of RCD protection to stand-alone ports.		P
	(h) The decisive voltage class (DVC).		P
9.3.4	External and ancillary equipment		N/A
	Where an inverter or multiple inverter combinations requires external or ancillary equipment for compliance with this Standard, the documentation shall—		N/A
	(a) state the requirement for any such equipment;		N/A
	(b) provide sufficient information to identify the external or ancillary equipment, either by manufacturer and part number or by type and rating; and		N/A
	(c) specify assembly, location, mounting and connection requirements.		N/A
9.3.5	RCDs		N/A
	Where an external RCD is required, the following or an equivalent statement shall be included in the documentation: 'External RCD Required'. The documentation shall also state the rating and type of RCD required and provide instructions for the installation of the RCD.		N/A
9.3.6	Multiple mode inverters		P
	Where the inverter is capable of multiple mode operation, the documentation shall include the following:		P
	(a) Ratings and means of connection to each source of supply to the inverter or output from the inverter.		P
	(b) Any requirements related to wiring and external controls, including the method of maintaining neutral continuity within the electrical installation to any stand-alone ports as required.		P
	(c) Disconnection means and isolation means.		P
	(d) Overcurrent protection needed.		P
9.3.7	Multiple inverter combinations	No in such used	N/A

AS/NZS 4777.2			
Clause	Requirement - Test	Result - Remark	Verdict
	Where an inverter has been tested for use in a multiple inverter combination as per Clause 8, the documentation shall include the following:		N/A
	(a) Valid combinations of inverters.		N/A
	(b) Installation instructions for correct operation as a multiple inverter combination.		N/A
APPENDIX A	GENERAL TEST AND REPORTING REQUIREMENTS		P
APPENDIX B	POWER FACTOR TEST		P
APPENDIX C	HARMONIC CURRENT LIMIT TEST		P
APPENDIX D	TRANSIENT VOLTAGE LIMIT TEST		P
APPENDIX E	D.C. INJECTION TEST		P
APPENDIX F	ACTIVE ANTI-ISLANDING TEST		P
APPENDIX G	VOLTAGE AND FREQUENCY LIMITS (PASSIVE ANTI-ISLANDING PROTECTION) TESTS		P
APPENDIX H	LIMITS FOR SUSTAINED OPERATION		P
APPENDIX I	DEMAND AND POWER QUALITY RESPONSE MODE TESTING INCLUDING DISCONNECTION ON EXTERNAL SIGNAL		P
APPENDIX J	MULTIPLE INVERTER TESTING		P
APPENDIX K	RELATED DOCUMENTS		Info.

**Appendix Table:**

5.5	TABLE: Power factor test						P
Model	HYD 6000-ES						
Mode	Measurement	15%	25%	50%	75%	100%	
Unity	Power (W)	902.26	1512.72	3006.98	4513.17	6005.25	
	Reactive power (Var)	371.38	417.67	500.18	579.58	484.41	
	PF	0.9247	0.9639	0.9864	0.9919	0.9936	
	Lead/lag	Lag	Lag	Lag	Lag	Lag	
Model	HYD 3000-ES						
Mode	Measurement	15%	25%	50%	75%	100%	
Unity	Power (W)	452.63	755.53	1500.45	2251.98	3007.30	
	Reactive power (Var)	183.37	202.99	262.86	307.52	383.20	
	PF	0.9268	0.9657	0.9850	0.9908	0.9920	
	Lead/lag	Lag	Lag	Lag	Lag	Lag	

5.6	TABLE: Harmonic current limit test						P
<b>Background voltage harmonics</b>							
Component	Limit of fundamental	Value V	% of fundamental	Component	Limit of fundamental	Value V	% of fundamental
1	--	231.8106	100.0000	26	0.1%	0.0071	0.0030
2	0.2%	0.0121	0.0052	27	0.1%	0.0136	0.0059
3	0.9%	0.0269	0.0116	28	0.1%	0.0043	0.0018
4	0.2%	0.0050	0.0021	29	0.1%	0.0125	0.0054
5	0.4%	0.0166	0.0071	30	0.1%	0.0040	0.0017
6	0.2%	0.0087	0.0038	31	0.1%	0.0155	0.0067
7	0.3%	0.0314	0.0135	32	0.1%	0.0039	0.0017
8	0.2%	0.0132	0.0057	33	0.1%	0.0120	0.0052
9	0.2%	0.0133	0.0057	34	0.1%	0.0057	0.0025
10	0.1%	0.0069	0.0030	35	0.1%	0.0132	0.0057
11	0.1%	0.0061	0.0026	36	0.1%	0.0057	0.0024
12	0.1%	0.0093	0.0040	37	0.1%	0.0124	0.0053
13	0.1%	0.0063	0.0027	38	0.1%	0.0050	0.0021
14	0.1%	0.0098	0.0043	39	0.1%	0.0121	0.0052
15	0.1%	0.0215	0.0093	40	0.1%	0.0063	0.0028
16	0.1%	0.0135	0.0058	41	0.1%	0.0132	0.0057
17	0.1%	0.0118	0.0051	42	0.1%	0.0059	0.0025



18	0.1%	0.0085	0.0036	43	0.1%	0.0115	0.0050
19	0.1%	0.0152	0.0065	44	0.1%	0.0046	0.0020
20	0.1%	0.0057	0.0024	45	0.1%	0.0112	0.0048
21	0.1%	0.0209	0.0090	46	0.1%	0.0059	0.0026
22	0.1%	0.0063	0.0027	47	0.1%	0.0110	0.0047
23	0.1%	0.0177	0.0076	48	0.1%	0.0064	0.0028
24	0.1%	0.0080	0.0035	49	0.1%	0.0119	0.0051
25	0.1%	0.0240	0.0104	50	0.1%	0.0069	0.0030
Total harmonic distortion (to 50th component)	5%	0.0220%					

Harmonic current limit test							
Model	HYD 6000-ES						
Component	Limit	50% of rated current			100% of rated current		
	of fundamental	Value A	Angle degrees	% of fundamental	Value A	Angle degrees	% of fundamental
1	--	13.2062	0	99.9825	26.0620	0	99.9937
2	1%	0.0078	0	0.0587	0.0207	0	0.0795
3	4%	0.2238	0	1.6945	0.2614	0	1.0032
4	1%	0.0025	0	0.0191	0.0069	0	0.0266
5	4%	0.0815	0	0.6169	0.0517	0	0.1982
6	1%	0.0026	0	0.0194	0.0215	0	0.0823
7	4%	0.0400	0	0.3032	0.0539	0	0.2070
8	1%	0.0024	0	0.0183	0.0219	0	0.0839
9	2%	0.0191	0	0.1449	0.0210	0	0.0804
10	0.5%	0.0033	0	0.0246	0.0119	0	0.0455
11	2%	0.0084	0	0.0637	0.0130	0	0.0499
12	0.5%	0.0035	0	0.0263	0.0065	0	0.0250
13	2%	0.0045	0	0.0339	0.0145	0	0.0556
14	0.5%	0.0039	0	0.0291	0.0147	0	0.0564
15	1%	0.0046	0	0.0347	0.0372	0	0.1426
16	0.5%	0.0042	0	0.0317	0.0150	0	0.0575
17	1%	0.0082	0	0.0620	0.0155	0	0.0592
18	0.5%	0.0032	0	0.0243	0.0079	0	0.0303
19	1%	0.0090	0	0.0680	0.0257	0	0.0985
20	0.5%	0.0022	0	0.0165	0.0038	0	0.0146
21	0.6%	0.0095	0	0.0717	0.0299	0	0.1149

22	0.5%	0.0019	0	0.0143	0.0071	0	0.0274
23	0.6%	0.0141	0	0.1063	0.0220	0	0.0845
24	0.5%	0.0019	0	0.0141	0.0068	0	0.0263
25	0.6%	0.0137	0	0.1034	0.0293	0	0.1124
26	0.5%	0.0023	0	0.0173	0.0048	0	0.0185
27	0.6%	0.0099	0	0.0747	0.0194	0	0.0744
28	0.5%	0.0012	0	0.0089	0.0024	0	0.0091
29	0.6%	0.0089	0	0.0670	0.0179	0	0.0686
30	0.5%	0.0012	0	0.0094	0.0025	0	0.0095
31	0.6%	0.0085	0	0.0646	0.0196	0	0.0753
32	0.5%	0.0016	0	0.0123	0.0033	0	0.0128
33	0.6%	0.0081	0	0.0611	0.0145	0	0.0556
Total harmonic distortion (to 50th component)	5%	1.039%			0.938%		

**Harmonic current limit test**

Model	HYD 3000-ES						
Component	Limit	50% of rated current			100% of rated current		
	% of fundamental	Value A	Angle degrees	% of fundamental	Value A	Angle degrees	% of fundamental
1	--	6.6475	0	99.9660	13.2091	0	99.9890
2	1%	0.0040	0	0.0610	0.0040	0	0.0310
3	4%	0.1549	0	2.3290	0.1759	0	1.3310
4	1%	0.0010	0	0.0150	0.0078	0	0.0590
5	4%	0.0593	0	0.8920	0.0534	0	0.4040
6	1%	0.0008	0	0.0110	0.0087	0	0.0660
7	4%	0.0294	0	0.4430	0.0276	0	0.2090
8	1%	0.0019	0	0.0290	0.0034	0	0.0260
9	2%	0.0166	0	0.2490	0.0140	0	0.1060
10	0.5%	0.0019	0	0.0290	0.0024	0	0.0180
11	2%	0.0078	0	0.1180	0.0053	0	0.0400
12	0.5%	0.0028	0	0.0430	0.0046	0	0.0350
13	2%	0.0025	0	0.0380	0.0040	0	0.0300
14	0.5%	0.0033	0	0.0500	0.0013	0	0.0100
15	1%	0.0007	0	0.0100	0.0052	0	0.0390
16	0.5%	0.0020	0	0.0300	0.0024	0	0.0180
17	1%	0.0012	0	0.0170	0.0064	0	0.0490

18	0.5%	0.0013	0	0.0200	0.0002	0	0.0010
19	1%	0.0048	0	0.0720	0.0169	0	0.1280
20	0.5%	0.0026	0	0.0380	0.0017	0	0.0130
21	0.6%	0.0074	0	0.1120	0.0133	0	0.1010
22	0.5%	0.0018	0	0.0270	0.0006	0	0.0040
23	0.6%	0.0094	0	0.1410	0.0120	0	0.0910
24	0.5%	0.0047	0	0.0710	0.0024	0	0.0180
25	0.6%	0.0071	0	0.1070	0.0092	0	0.0700
26	0.5%	0.0005	0	0.0080	0.0023	0	0.0170
27	0.6%	0.0049	0	0.0740	0.0102	0	0.0770
28	0.5%	0.0007	0	0.0110	0.0014	0	0.0110
29	0.6%	0.0087	0	0.1300	0.0096	0	0.0730
30	0.5%	0.0013	0	0.0190	0.0023	0	0.0170
31	0.6%	0.0078	0	0.1170	0.0084	0	0.0640
32	0.5%	0.0004	0	0.0060	0.0028	0	0.0210
33	0.6%	0.0067	0	0.1000	0.0080	0	0.0610
Total harmonic distortion (to 50th component)	5%	2.596%			1.449%		

Note: The impedance of the grid source:0.1Ω

5.7	TABLE: Voltage fluctuations and flicker				P
Model	HYD 6000-ES				
	Starting	Stopping	Running		
Limit	4%	4%	Pst = 1.0	Plt = 0.65	
Test value	2.15	1.99	0.43	0.41	
The Test inverters' flicker level was found to be lower than the permissible limit as per AS61000.3.3					

5.7	TABLE: Voltage fluctuations and flicker				P
Model	HYD 3000-ES				
	Starting	Stopping	Running		
Limit	4%	4%	Pst = 1.0	Plt = 0.65	
Test value	1.00	0.55	0.23	0.23	
The Test inverters' flicker level was found to be lower than the permissible limit as per AS61000.3.3					

5.8	TABLE: Transient voltage limit test					P
Condition	Duration Seconds	Required (V)	Line-to- neutral volts	Required (V)	Line-to-line volts	
10(±5)% of rated output (VA)	0,000 2	910	456.25	1580	--	
	0,000 6	710	456.25	1240	--	
	0,002	580	456.50	1010	--	
	0,006	470	231.25	810	--	
	0,02	420	231.25	720	--	
	0,06	390	237.5	670	--	
	0,2	390	200.00	670	--	
	0,6	390	118.75	670	--	
50(±5)% of rated output (VA)	0,000 2	910	437.50	1580	--	
	0,000 6	710	431.25	1240	--	
	0,002	580	437.50	1010	--	
	0,006	470	381.25	810	--	
	0,02	420	81.25	720	--	
	0,06	390	75.00	670	--	
	0,2	390	81.25	670	--	
	0,6	390	62.50	670	--	
100(±5)% of rated output (VA)	0,000 2	910	425.00	1580	--	
	0,000 6	710	418.75	1240	--	
	0,002	580	437.50	1010	--	
	0,006	470	431.25	810	--	
	0,02	420	318.75	720	--	
	0,06	390	300.00	670	--	
	0,2	390	243.75	670	--	
	0,6	390	156.25	670	--	

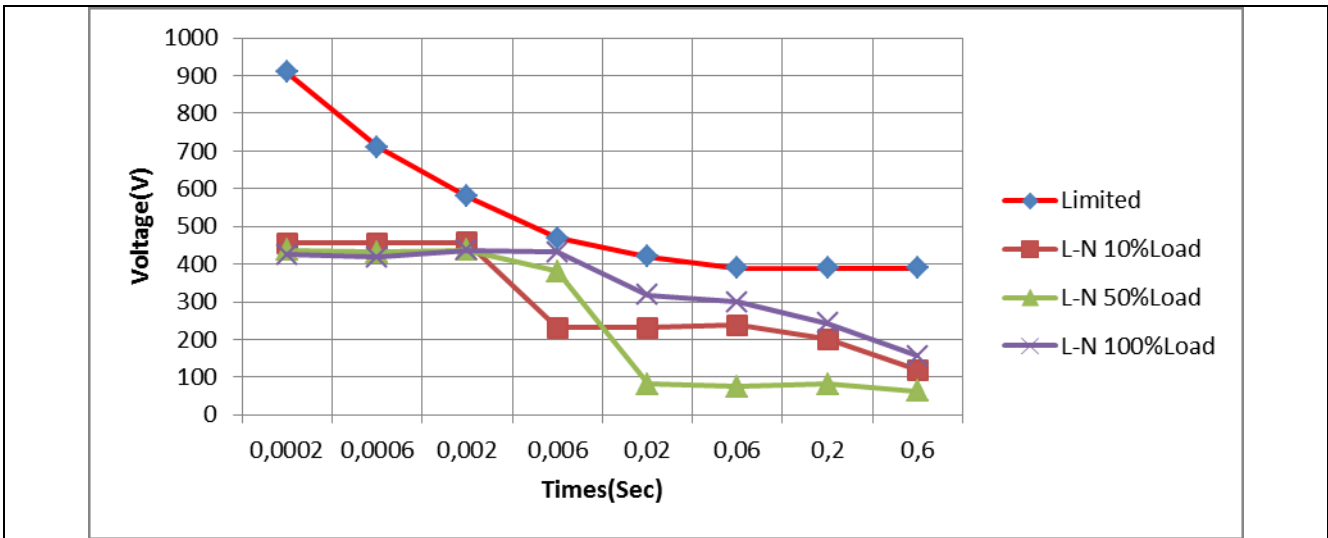

5.9	TABLE: Direct current injection test			N/A
Model: HYD 6000-ES				
		20%	60%	100%
Inverter current, A	Setting	5.22	15.65	26.09
	Actual	5.20	15.71	26.12
Limit(A)	$0.5\% \times I_{rated} (A)$	0.130	0.130	0.130
Result	A	0.0030	0.0012	0.0021
Compliance	(P/F)	P	P	P
Model: HYD 3000-ES				
		20%	60%	100%
Inverter current, A	Setting	2.61	7.83	13.04
	Actual	2.78	7.87	13.09
Limit(A)	$0.5\% \times I_{rated} (A)$	0.0652	0.0652	0.0652
Result	A	0.0071	0.0037	0.0055
Compliance	(P/F)	P	P	P

6.3.2.2	TABLE: Volt - watt response mode			P
Model: HYD 6000-ES				
Item	Aus. default Value, V	Power measurement, W	Measurement value (P/Prated), %	Maximum value (P/Prated), %
1	200	5969.17	99.49	100
2	207	5977.56	99.63	100
3	210	5984.00	99.73	100
4	220	5993.57	99.89	100

5	230	5996.25	99.94	100
6	240	6011.69	100.19	100
7	250	5996.82	99.95	100
8	265	1150.00	19.17	20

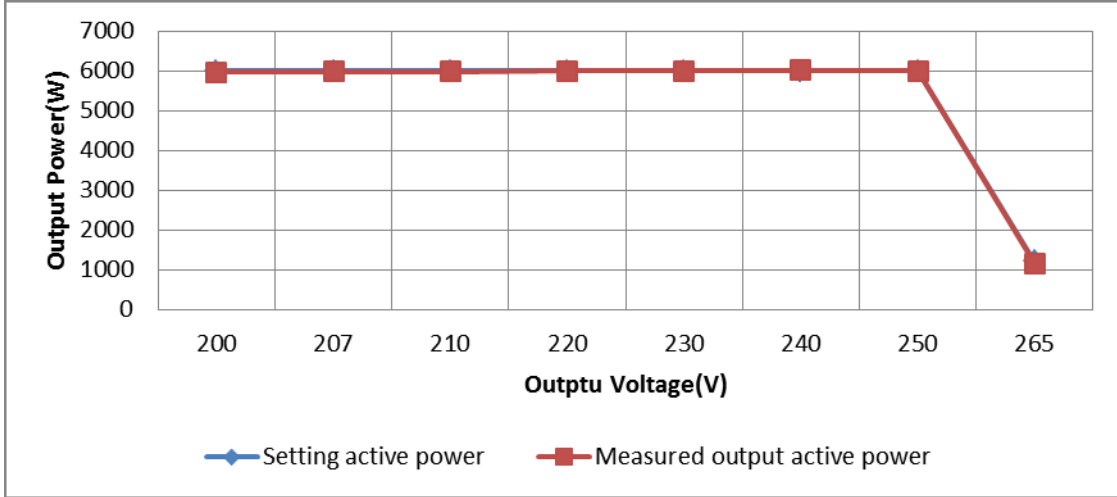

**CURVE FOR A VOLT - WATT RESPONSE MODE (AUSTRALIA)**

Item	NZ default Value	Power measurement, W	Measurement value (P/Prated), %	Maximum value (P/Prated), %
1	200	5993.66	99.89	100
2	207	6016.17	100.3	100
3	210	6004.73	100.07	100
4	220	5949.62	99.16	100
5	230	5894.91	98.25	100
6	240	5875.08	97.92	100
7	244	6029.24	100.49	100
8	255	1128.59	18.81	20

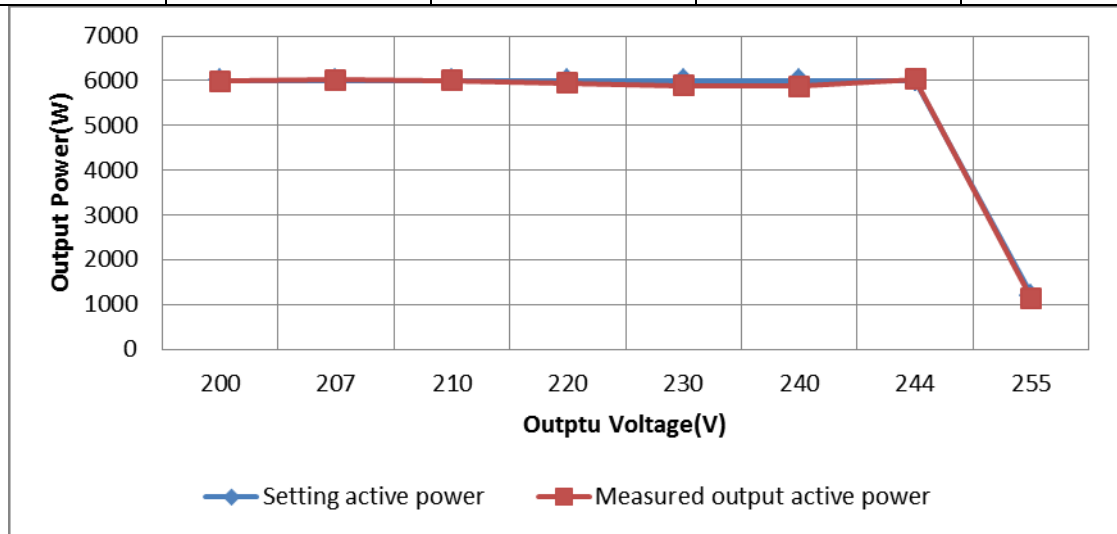

**CURVE FOR A VOLT - WATT RESPONSE MODE (New Zealand)**

**6.3.2.3**      **TABLE: Volt - Var response mode**      **P**

Model: HYD 6000-ES

Item	Aus. default Value, V	Default values for var level (var % rated VA)	Reactive measurement, Var	VAR/RATED, VA (%)
1	200	30% Leading	1780.18	29.67
2	207	30% Leading	1782.81	29.71
3	220	0	-205.02	-3.42
4	230	0	-217.33	-3.62
5	240	0	-201.44	-3.36
6	250	0	-215.29	-3.59
7	265	30% Lagging	-1772.47	-29.54

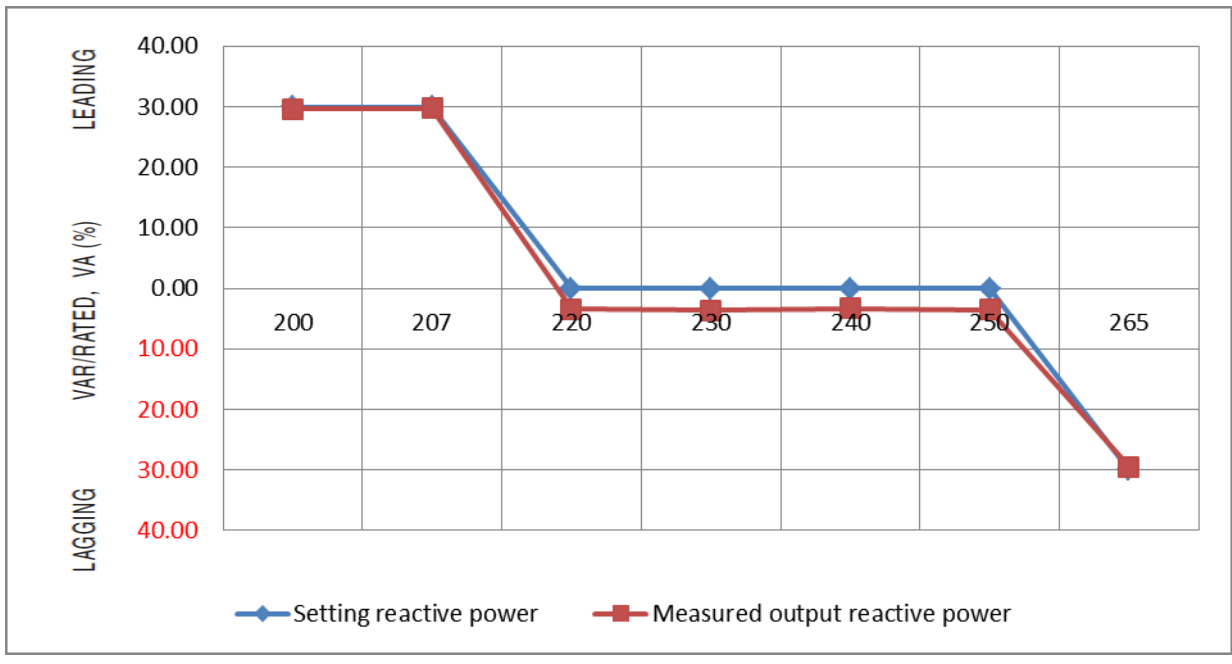

Item	NZ. default Value, V	Default values for var level (var % rated VA)	Reactive measurement, K Var	VAR/RATED, VA (%)
1	200	30% Leading	1799.40	29.99
2	207	30% Leading	1803.86	30.06
3	220	0	-200.89	-3.35
4	230	0	-209.69	-3.49
5	240	0	-224.66	-3.74
6	244	0	-208.38	-3.47
7	255	30% Lagging	-1799.40	-29.99



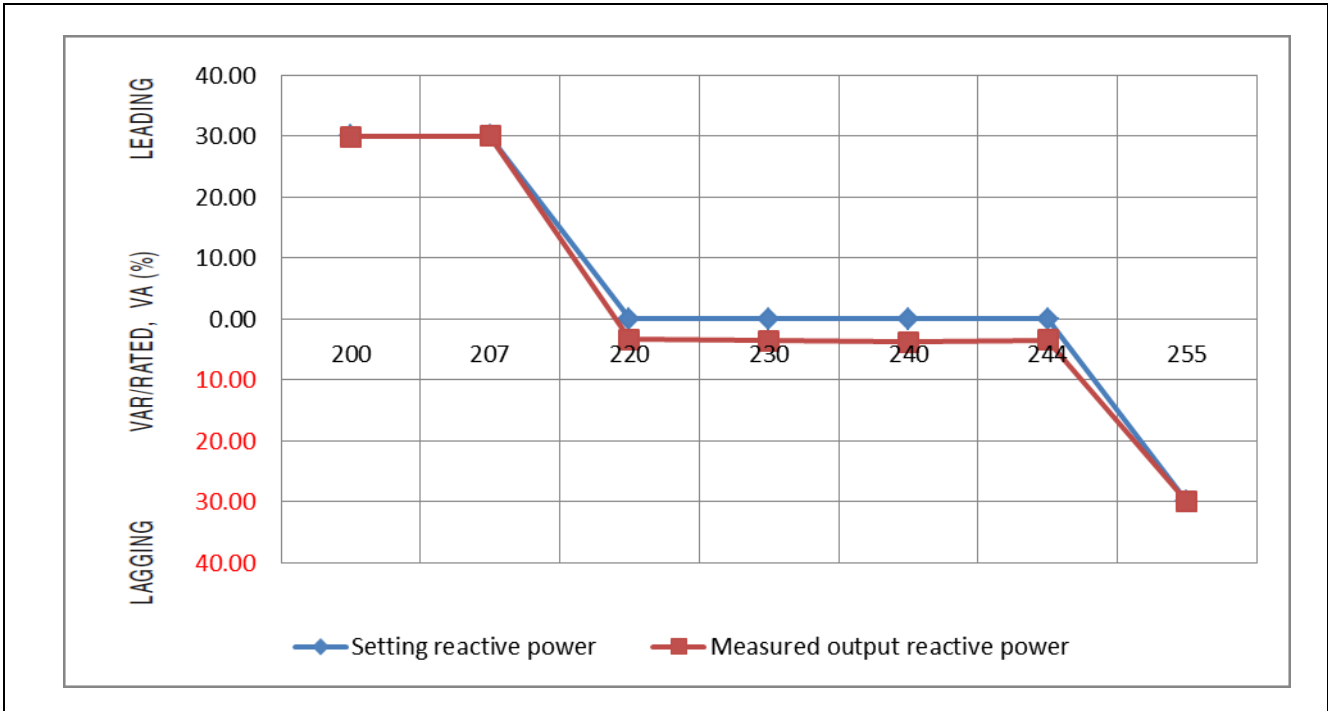

6.3.3	Fixed reactive power mode					P
Model: HYD 6000-ES						
Setting of rated W	P(W) ind.	Q(Var) ind, max	PF ind, max	P(W) cap.	Q(Var) cap. max	PF cap, max
0%	94.63	510.05	0.1825	89.50	488.20	0.1800
10%	618.73	2995.48	0.2023	622.07	4234.07	0.1500
20%	1199.13	3386.98	0.3337	1228.65	3787.16	0.3086
30%	1814.77	3518.29	0.4584	1830.72	3753.19	0.4384
40%	2398.38	3593.31	0.5552	2407.35	3677.01	0.5478
50%	3006.34	3627.03	0.6382	3020.28	3644.43	0.6381
60%	3604.96	3647.11	0.703	3618.21	3645.51	0.7044
70%	4207.48	3661.47	0.7544	4221.19	3664.79	0.7751
80%	4818.02	3666.86	0.7958	4811.137	3672.89	0.7949
90%	5414.31	3664.54	0.8281*	5425.63	3688.58	0.8270*
100%	5781.23	3646.434	0.8458*	5743.77	3670.34	0.8426*
*The inverter is limited by the Max power that can't attain the intend loading.						

6.3.3		Fixed power factor mode				P
Model: HYD 6000-ES						
Setting of rated W	PF (setting)	P(W)	S(VA)	Q(Var)	PF	
0%	0.80 lagging	279.4327	405.3445	293.6314	0.6894	
10%	0.80 lagging	714.61	961.71	643.60	0.7431	
20%	0.80 lagging	1211.81	1558.96	980.75	0.7800	
30%	0.80 lagging	1811.98	2280.43	1384.58	0.7946	
40%	0.80 lagging	2410.17	3002.07	1789.82	0.8028	
50%	0.80 lagging	3013.35	3731.61	2201.05	0.8075	
60%	0.80 lagging	3600.65	4492.81	2687.13	0.8014	
70%	0.80 lagging	4211.67	5241.28	3119.74	0.8036	
80%	0.80 lagging	4801.74	5965.21	3539.35	0.8050	
90%	0.80 lagging	5423.00	6725.26	3977.46	0.8064	
100%	0.80 lagging	5871.91	7274.16	4293.49	0.8072	
Setting of rated W	PF (setting)	P(W)	S(VA)	Q(Var)	PF	
0%	0.80 leading	288.95	324.49	147.61	0.8905	
10%	0.80 leading	616.72	740.35	409.60	0.8330	
20%	0.80 leading	1209.24	1493.03	875.72	0.8099	
30%	0.80 leading	1799.07	2244.14	341.47	0.8017	
40%	0.80 leading	2413.62	3029.65	1831.18	0.7967	
50%	0.80 leading	3005.14	3787.04	2304.52	0.7935	
60%	0.80 leading	3602.54	4551.42	2781.55	0.7915	
70%	0.80 leading	4224.55	5279.76	-166.87	0.8001	
80%	0.80 leading	4813.94	6024.28	3621.85	0.7991	
90%	0.80 leading	5416.15	6782.62	4082.79	0.7980	
100%	0.80 leading	5676.186	7112.859	4286.44	0.7991	
Setting of rated W	PF (setting)	P(W)	S(VA)	Q(Var)	PF	
0%	1	280.99	331.46	175.79	0.8477	
10%	1	619.29	653.46	208.52	0.9477	
20%	1	1211.42	1241.15	269.95	0.9760	
30%	1	1820.89	1836.53	310.37	0.9910	
40%	1	2406.76	2427.36	339.81	0.9912	
50%	1	3008.16	3030.63	356.56	0.9926	

60%	1	3615.65	3637.58	178.11	0.9940
70%	1	4202.13	4224.29	432.04	0.9948
80%	1	4813.36	4836.27	470.11	0.9953
90%	1	5404.31	5428.36	510.31	0.9956
100%	1	5917.12	5942.49	548.38	0.9957

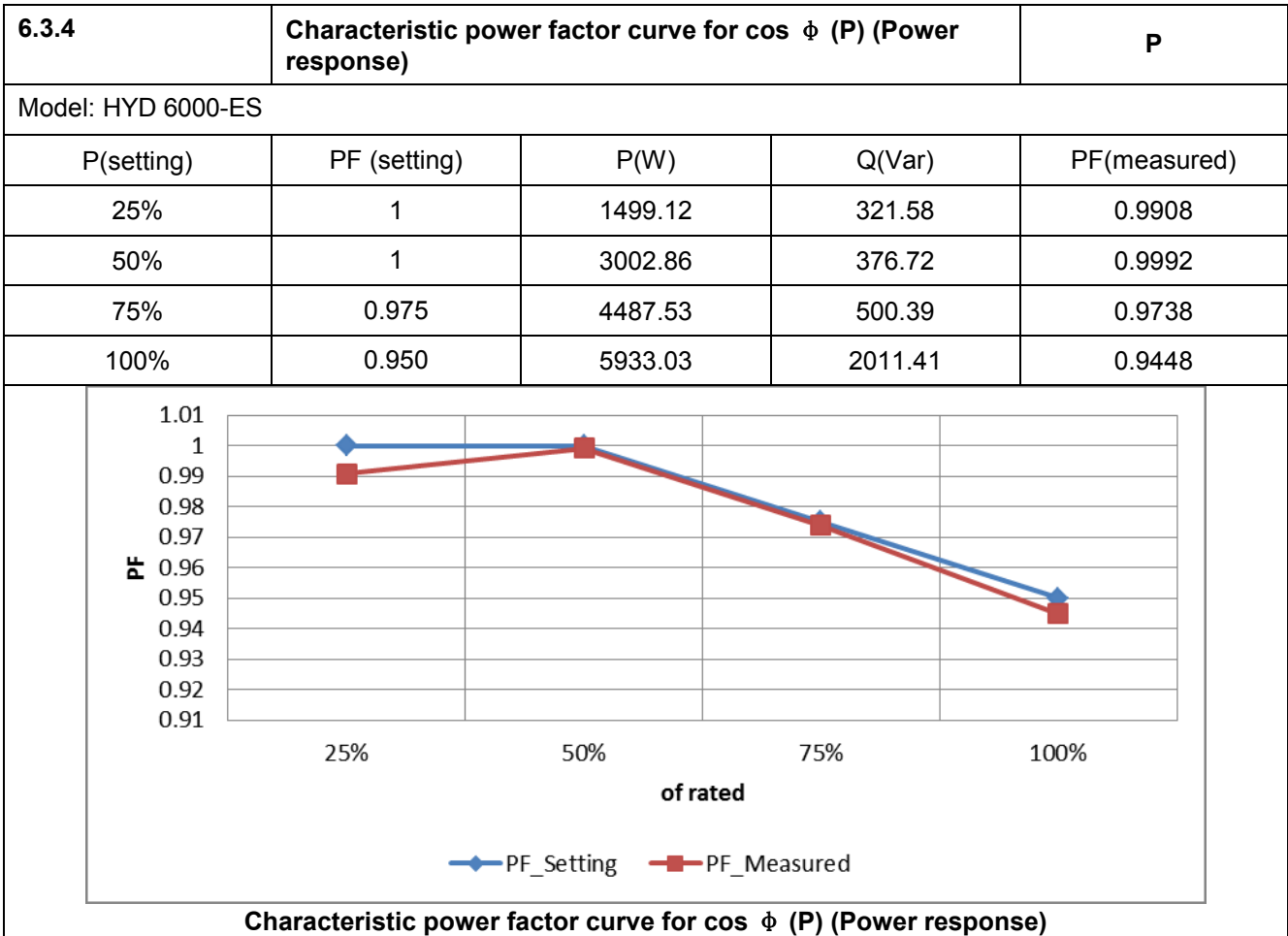

<b>6.4.2</b>	<b>TABLE: Sinusoidal output in stand-alone mode test</b>								<b>P</b>	
Component	Limit	5% power or the lowest continuous available output power greater than 5%			50% of rated power			100% of rated power		
	% of fundamental	Value V	Angle degrees	% of fundamental	Value V	Angle degrees	% of fundamental	Value V	Angle degrees	% of fundamental
1	100%	233.89	--	100.00	225.25	--	99.98	223.78	--	99.97
2	5%	0.0397	--	0.0170	0.0650	--	0.0290	0.1690	--	0.0755
3	5%	1.8379	--	0.7858	3.5702	--	1.5850	4.3776	--	1.9557

4	5%	0.0151	--	0.0065	0.0590	--	0.0260	0.0333	--	0.0149
5	5%	1.7415	--	0.7446	1.9191	--	0.8520	2.0681	--	0.9239
6	5%	0.0113	--	0.0048	0.0428	--	0.0190	0.0446	--	0.0199
7	5%	1.1262	--	0.4815	1.2990	--	0.5770	1.3785	--	0.6158
8	5%	0.0487	--	0.0208	0.0468	--	0.0210	0.0346	--	0.0155
9	5%	1.0163	--	0.4345	0.9610	--	0.4270	1.0282	--	0.4593
10	5%	0.0768	--	0.0328	0.0524	--	0.0230	0.0417	--	0.0187
11	5%	0.2994	--	0.1280	0.7346	--	0.3260	0.8013	--	0.3580
12	5%	0.0029	--	0.0012	0.0346	--	0.0150	0.0343	--	0.0153
13	5%	0.6318	--	0.2701	0.5928	--	0.2630	0.6496	--	0.2903
14	5%	0.0479	--	0.0205	0.0406	--	0.0180	0.0374	--	0.0167
15	5%	0.5393	--	0.2306	0.4869	--	0.2160	0.5351	--	0.2391
16	5%	0.0238	--	0.0102	0.0430	--	0.0190	0.0327	--	0.0146
17	5%	0.8404	--	0.3593	0.3945	--	0.1750	0.4427	--	0.1977
18	5%	0.0108	--	0.0046	0.0264	--	0.0120	0.0318	--	0.0142
19	5%	0.2516	--	0.1076	0.3425	--	0.1520	0.3787	--	0.1692
20	5%	0.0026	--	0.0011	0.0223	--	0.0100	0.0320	--	0.0143
21	5%	0.2872	--	0.1228	0.3062	--	0.1360	0.3164	--	0.1414
22	5%	0.0195	--	0.0083	0.0359	--	0.0160	0.0296	--	0.0132
23	5%	0.3592	--	0.1536	0.2490	--	0.1110	0.2725	--	0.1217
24	5%	0.0388	--	0.0166	0.0414	--	0.0180	0.0297	--	0.0133
25	5%	0.2348	--	0.1004	0.2331	--	0.1030	0.2325	--	0.1039
26	5%	0.0279	--	0.0119	0.0303	--	0.0130	0.0259	--	0.0116
27	5%	0.1173	--	0.0501	0.1870	--	0.0830	0.1976	--	0.0882
28	5%	0.0158	--	0.0067	0.0186	--	0.0080	0.0270	--	0.0121
29	5%	0.2275	--	0.0973	0.1821	--	0.0810	0.1719	--	0.0768
30	5%	0.0163	--	0.0070	0.0086	--	0.0040	0.0251	--	0.0112
31	5%	0.2090	--	0.0894	0.1548	--	0.0690	0.1499	--	0.0670
32	5%	0.0124	--	0.0053	0.0327	--	0.0150	0.0236	--	0.0105
33	5%	0.0909	--	0.0389	0.1395	--	0.0620	0.1307	--	0.0584
34	5%	0.0130	--	0.0056	0.0160	--	0.0070	0.0227	--	0.0102
35	5%	0.0634	--	0.0271	0.0921	--	0.0410	0.1108	--	0.0495
36	5%	0.0243	--	0.0104	0.0151	--	0.0070	0.0196	--	0.0088
37	5%	0.0869	--	0.0372	0.0669	--	0.0300	0.1058	--	0.0473
38	5%	0.0356	--	0.0152	0.0328	--	0.0150	0.0220	--	0.0098
39	5%	0.0843	--	0.0360	0.0787	--	0.0350	0.0871	--	0.0389
40	5%	0.0154	--	0.0066	0.0174	--	0.0080	0.0168	--	0.0075

41	5%	0.0807	--	0.0345	0.0472	--	0.0210	0.0849	--	0.0380
42	5%	0.0038	--	0.0016	0.0078	--	0.0030	0.0182	--	0.0081
43	5%	0.0109	--	0.0047	0.0472	--	0.0210	0.0743	--	0.0332
44	5%	0.0067	--	0.0029	0.0240	--	0.0110	0.0157	--	0.0070
45	5%	0.0112	--	0.0048	0.0369	--	0.0160	0.0648	--	0.0289
46	5%	0.0091	--	0.0039	0.0215	--	0.0100	0.0138	--	0.0062
47	5%	0.0556	--	0.0238	0.0199	--	0.0090	0.0654	--	0.0293
48	5%	0.0159	--	0.0068	0.0108	--	0.0050	0.0175	--	0.0078
49	5%	0.0564	--	0.0241	0.0343	--	0.0150	0.0529	--	0.0236
50	5%	0.0112	--	0.0048	0.0171	--	0.0080	0.0107	--	0.0048
Total harmonic distortion (to 50th component)	5%	1.434%			2.289%			2.614%		

**6.4.3** TABLE: Volt - watt response mode for charging of energy storage **P**

Model: HYD 6000-ES

Item	Default Value, V	Power measurement, W	Measurement value (P/Prated), %	Maximum value (P/Prated), %
1	200	0.3902	0.01	0
2	207	0.4042	0.01	0
3	220	2959.92	98.66	100
4	250	2961.67	98.72	100
5	265	2959.42	98.65	100

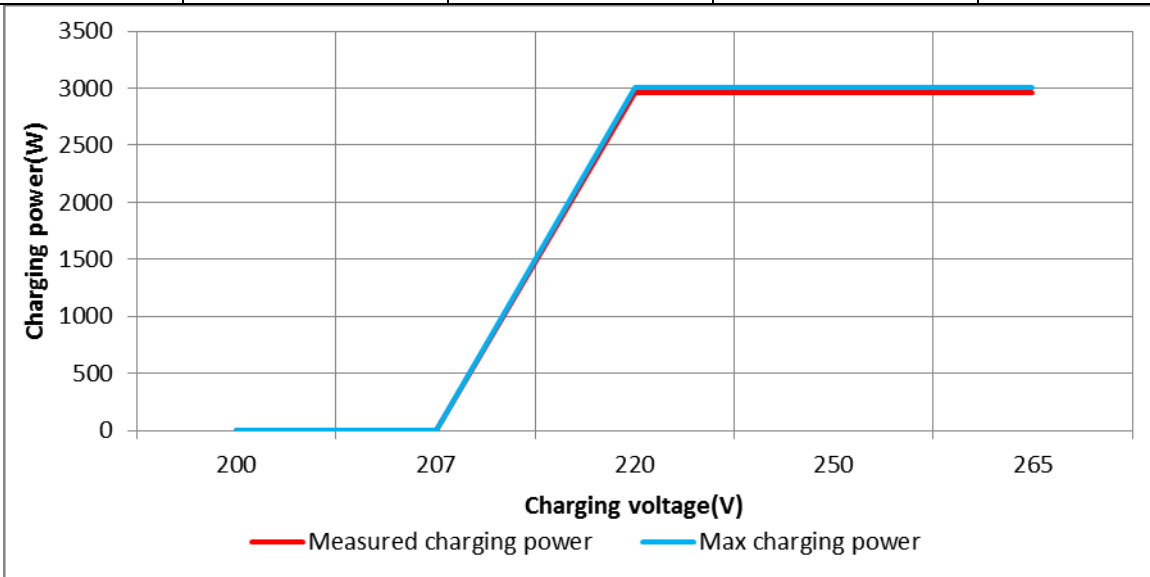

7.3		Active anti-islanding protection								P		
Model: HYD 6000-ES												
Test condition		Frequency=50Hz, $U_N=230$ , Quality = 1 , Distortion factor of chokes < 2%										
Test method		According to IEC 62116.										
No.	PEUT <sup>1)</sup> (% of EUT rating)	Reactive load (% of QL in 6.1.d) <sup>1)</sup>	PAC <sup>2)</sup> (% of nominal)	QAC <sup>3)</sup> (% of nominal)	Run on time (ms)	PEUT (KW)	Actual Qf	VDC	Remarks <sup>4)</sup>			
1	100	100	0	0	386.0	6040	1.00	550	Test	A	at	BL
2	66	66	0	0	242.0	3960	1.00	340	Test	B	at	BL
3	33	33	0	0	312.0	1980	1.00	130	Test	C	at	BL
4	100	100	-5	-5	210.0	6040	1.02	550	Test	A	at	IB
5	100	100	-5	0	194.5	6040	1.00	550	Test	A	at	IB
6	100	100	-5	5	244.5	6040	0.97	550	Test	A	at	IB
7	100	100	0	-5	199.0	6040	1.02	550	Test	A	at	IB
8	100	100	0	5	204.0	6040	1.00	550	Test	A	at	IB
9	100	100	5	-5	268.0	6040	0.97	550	Test	A	at	IB
10	100	100	5	0	288.0	6040	1.02	550	Test	A	at	IB
11	100	100	5	5	274.0	6040	1.00	550	Test	A	at	IB
12	66	66	0	-5	300.0	3960	1.02	340	Test	B	at	IB
13	66	66	0	-4	345.0	3960	1.02	340	Test	B	at	IB
14	66	66	0	-3	228.5	3960	1.01	340	Test	B	at	IB
15	66	66	0	-2	228.0	3960	1.01	340	Test	B	at	IB
16	66	66	0	-1	209.5	3960	1.00	340	Test	B	at	IB
17	66	66	0	1	292.0	3960	0.99	340	Test	B	at	IB
18	66	66	0	2	397.0	3960	0.99	340	Test	B	at	IB
19	66	66	0	3	254.8	3960	0.98	340	Test	B	at	IB
20	66	66	0	4	277.6	3960	0.98	340	Test	B	at	IB
21	66	66	0	5	259.2	3960	0.97	340	Test	B	at	IB
22	33	33	0	-5	252.9	1980	1.02	130	Test	C	at	IB
23	33	33	0	-4	292.5	1980	1.02	130	Test	C	at	IB
24	33	33	0	-3	198.8	1980	1.01	130	Test	C	at	IB
25	33	33	0	-2	357.0	1980	1.01	130	Test	C	at	IB
26	33	33	0	-1	231.3	1980	1.00	130	Test	C	at	IB
27	33	33	0	1	315.0	1980	0.99	130	Test	C	at	IB
28	33	33	0	2	234.4	1980	0.99	130	Test	C	at	IB
29	33	33	0	3	266.4	1980	0.98	130	Test	C	at	IB
30	33	33	0	4	247.8	1980	0.98	130	Test	C	at	IB
31	33	33	0	5	216.9	1980	0.97	130	Test	C	at	IB

Remark:

- 1) PEUT: EUT output power
- 2) PAC: Real power flow at S1 in Figure 1. Positive means power from EUT to utility. Nominal is the 0% test condition value.
- 3) QAC: Reactive power flow at S1 in Figure 1. Positive means power form EUT to utility. Nominal is the 0% test condition value.
- 4) BL: Balance condition, IB: Imbalance condition.

Condition	EUT output power, $P_{EUT}$	EUT input voltage <sup>c</sup>	EUT trip settings <sup>d</sup>
A	Maximum <sup>a</sup>	> 75 % of rated input voltage range	Voltage and frequency trip settings according to National standards and/or local code
B	50 % to 66 % of maximum	50 % of rated input voltage range, $\pm 10$ %	Voltage and frequency trip settings according to National standards and/or local code
C	25 % to 33 % <sup>b</sup> of maximum	< 20 % of rated input voltage range	Voltage and frequency trip settings according to National standards and/or local code

<sup>a</sup> Maximum EUT output power condition should be achieved using the maximum allowable input power. Actual output power may exceed nominal rated output.

<sup>b</sup> Or minimum allowable EUT output level if greater than 33 %.

<sup>c</sup> Based on EUT rated input operating range. For example, if range is between  $X$  volts and  $Y$  volts, 75 % of range =  $X + 0,75 \times (Y - X)$ .  $Y$  shall not exceed  $0,8 \times$  EUT maximum system voltage (i.e., maximum allowable array open circuit voltage). In any case, the EUT should not be operated outside of its allowable input voltage range.

Note: test A (100%): If any of the recorded run-on times are longer than the one recorded for the rated balance condition, i.e. test procedure 6.1 f), then the non-shaded parameter combinations (no.32~47) also require testing.

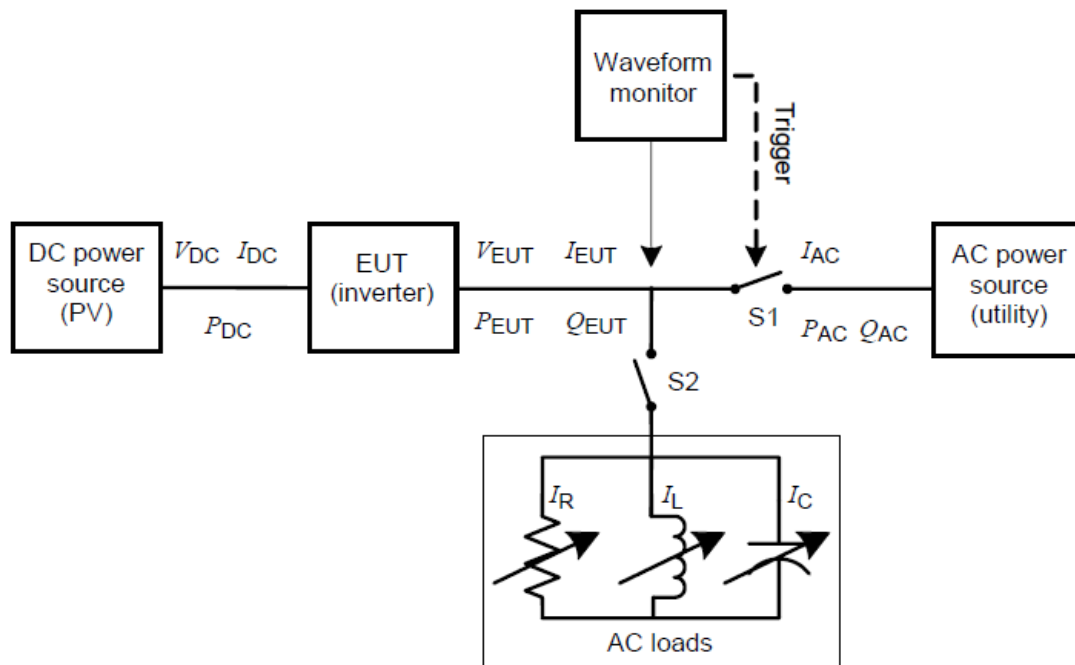

IEC 1567/08



$P_{EUT} 100\%$ ,  $P_{AC} 0\%$ ,  $Q_{AC} 0\%$ , = 386.0ms

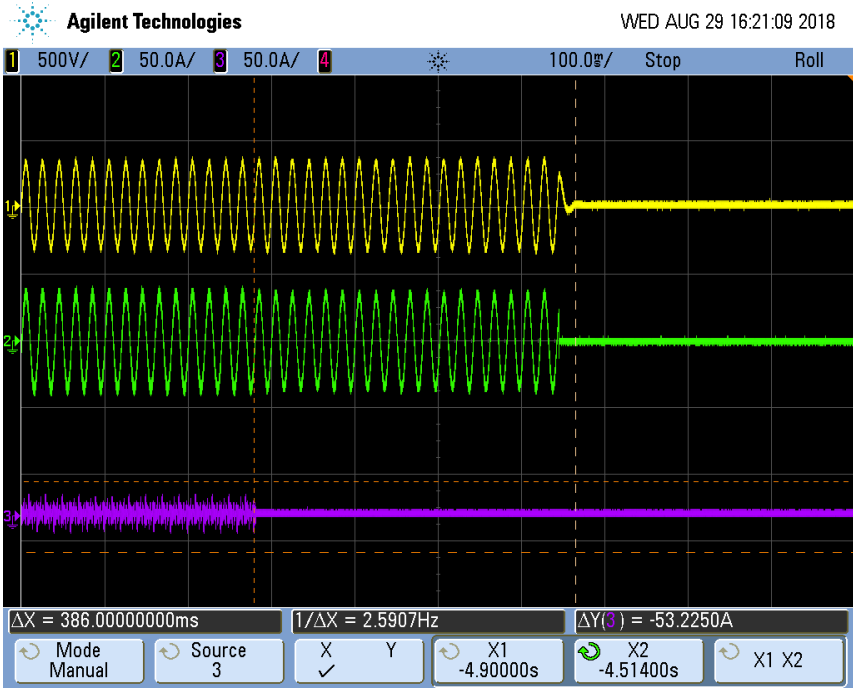

$P_{EUT} 66\%$ ,  $P_{AC} 0\%$ ,  $Q_{AC} 2\%$ , = 397.0ms

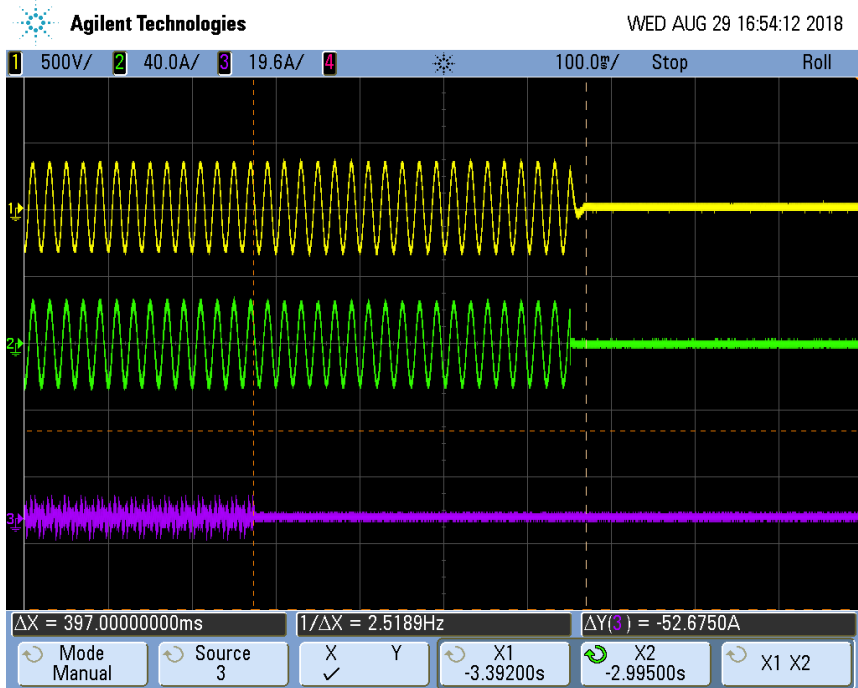

$P_{EUT} 33\%$ ,  $P_{AC} 0\%$ ,  $Q_{AC} -2\%$ , = 357.0ms

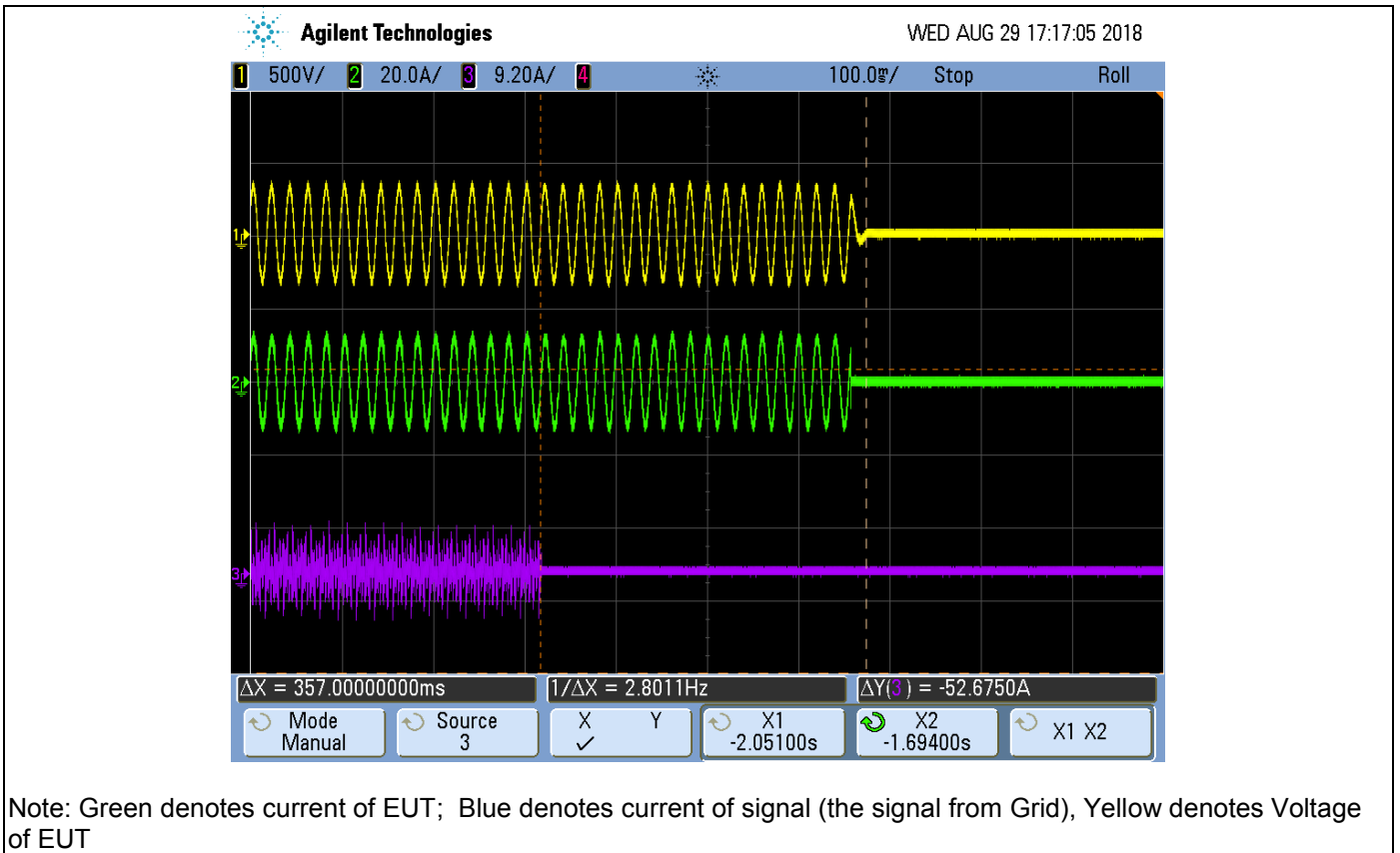

Appendix G2		TABLE: UNDERVOLTAGE AND OVERVOLTAGE TRIP SETTINGS AND RECONNECTION TEST			P
Grid Frequency (Hz)	50	Grid Voltage (Vac)	230		
Model	Under-voltage (V)	Disconnect time (seconds)	Reconnect time (seconds)	Setting trip voltage (Vac)	
HYD 6000-ES	181.0	1.220	65.0	180	
Model	Over-voltage (V)	Disconnect time (seconds)	Reconnect time (seconds)	Setting trip voltage (Vac)	
HYD 6000-ES	258.6	1.215	68.0	260	
HYD 6000-ES	263.2	0.116	67.0	265	

Appendix G3		TABLE: UNDER-FREQUENCY AND OVER-FREQUENCY TRIP SETTINGS AND RECONNECTION TEST			P
Grid Frequency (Hz)	50	Grid Voltage (Vac)	230		
Model	Under-frequency (Hz)	Disconnect time (seconds)	Reconnect time (seconds)	Setting trip frequency (Hz)	
HYD 6000-ES	47.07	1.212	68.4	47 (for Australia)	
HYD 6000-ES	45.00	1.293	68.2	45 Hz (for New Zealand)	
Model	Over-frequency (Hz)	Disconnect time (seconds)	Reconnect time (seconds)	Setting trip frequency (Hz)	
HYD 6000-ES	52.01	0.118	68.0	52	

Appendix H2		TABLE: SUSTAINED OPERATION FOR VOLTAGE VARIATIONS TEST		P
Test at 50 ±5% rated apparent power (VA):	3000	V <sub>nom_max</sub> setting (V):	248 (for New Zealand)	
Step	Measured average voltage (V)	Deviated from V <sub>nom_max</sub> set-point (%)	Limit	
(f)-1	247.79	-0.085	± 1%	
(f)-2	247.61	-0.157	± 1%	
(f)-3	247.86	-0.056	± 1%	
	The time to disconnect (s)		Limit (s)	
(i)	24.6		30	
	The time to reconnect (s)		Limit (s)	
(j)	68.0		60	
Test at 50 ±5% rated apparent power (VA):	3000	V <sub>nom_max</sub> setting (V):	255 (for Australia)	
Step	Measured average voltage (V)	Deviated from V <sub>nom_max</sub> set-point (%)	Limit	

(f)-1	254.34	-0.259	± 1%
(f)-2	254.43	-0.224	± 1%
(f)-3	254.45	0.216	± 1%
	The time to disconnect (s)		Limit (s)
(i)	24.6		30
	The time to reconnect (s)		Limit (s)
(j)	68.0		>60

Appendix H3.2	TABLE: Response to an increase in frequency test		P
(c) Test at 50 ±5% rated apparent power (VA):	3000	F <sub>stop</sub> (Hz):	52
(d) The average inverter power for 5 min P <sub>ref</sub> (W):	3008.2		
(f) Output frequency (Hz)	Average frequency (Hz)	Average power (W)	
50.1	50.10	3008.2	
50.2	50.20	3004.6	
50.3	50.30	2934.3	
50.4	50.40	2717.1	
50.5	50.50	2548.5	
50.6	50.60	2368.7	
50.7	50.70	2207.8	
50.8	50.80	2040.7	
50.9	50.90	1870.6	
51.0	51.00	1708.1	
51.1	51.10	1531.7	
51.2	51.20	1359.3	
51.3	51.30	1190.3	
51.4	51.40	1017.2	
51.5	51.50	867.9	
51.6	51.60	675.9	
51.7	51.70	506.8	
51.8	51.80	328.8	
51.9	51.90	147.2	
52.0	52.00	0	
52.1	52.10	0	
52.2	52.20	0	

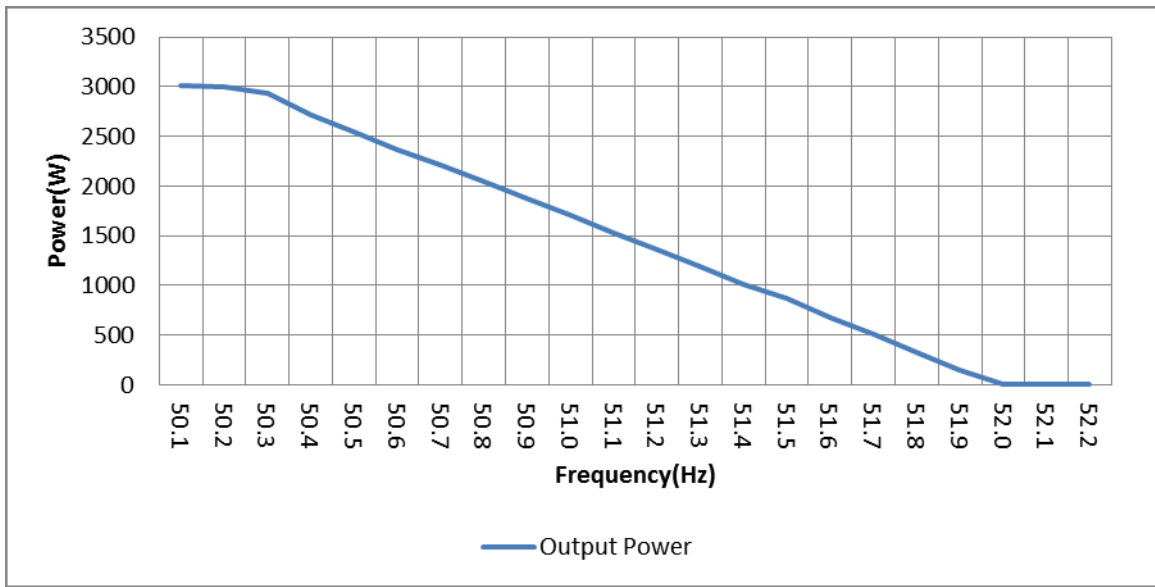

The graph of the step (f)

(i) Measured reconnection time (s)	72.0
Reconnection time limit (s)	> 60
Increase power rate (W/min.):	994.80
Rated power output (W):	6000
Increase power rate based on rated power output (%):	16.58
Power rate limit $W_{Gra}$ (%):	15.00 - 18.33

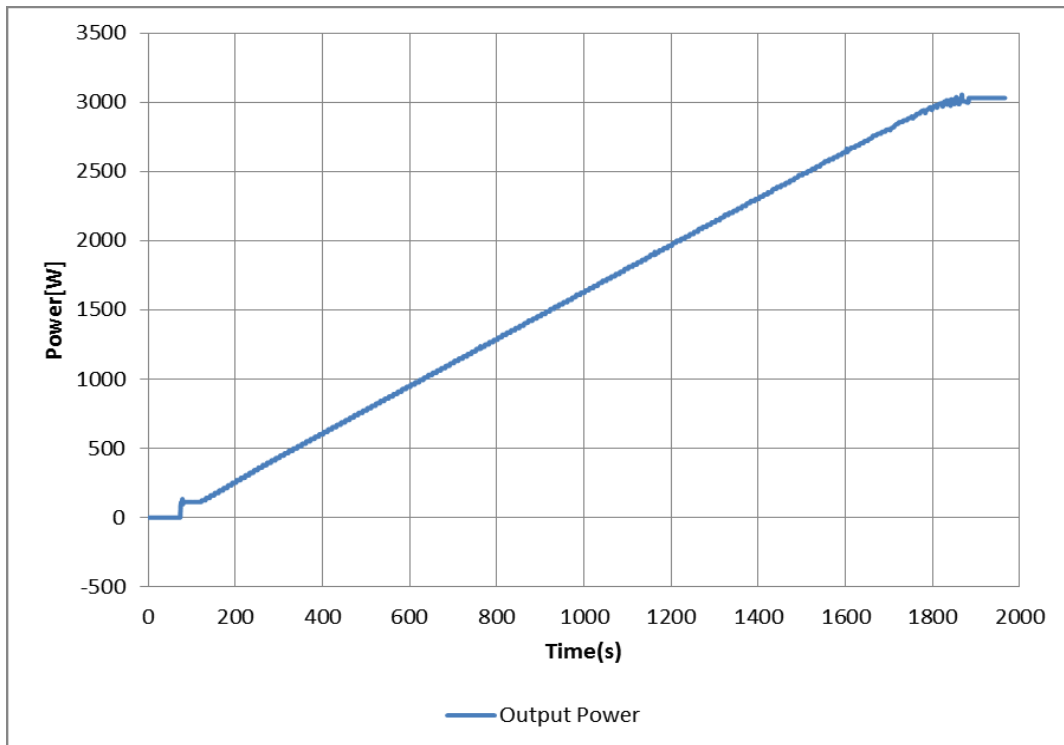

The graph of the step (i)

(j)	Repeat (c) Test at 50 ±5% rated apparent power (VA):	3000
	Repeat (d) The average inverter power for 5 min P <sub>ref</sub> (W):	3005.6
(k) Output frequency (Hz)		Average frequency (Hz)
50.1		50.10
50.2		50.20
50.3		50.30
50.4		50.40
50.5		50.50
50.6		50.60
50.7		50.70
50.8		50.80
50.9		50.90
51.0		51.00
		Average power (W)
50.1		3005.60
50.2		3002.70
50.3		2926.80
50.4		2707.80
50.5		2538.80
50.6		2373.90
50.7		2201.80
50.8		2031.50
50.9		1864.70
51.0		1702.4
<p>The graph of the step (k)</p>		
(m) Output frequency (Hz)		Average frequency (Hz)
51.0		51.00
50.8		50.80
50.6		50.60
50.4		50.40
50.2		50.20
		Average power (W)
51.0		1702.40
50.8		1698.50
50.6		1698.43
50.4		1698.59
50.2		1698.55
(n) Increase power rate (W/min.):		986.36
Rated power output (W):		6000
Increase power rate based on rated power output (%):		16.44
Power rate limit W <sub>Gra</sub> (%):		15.00 - 18.33

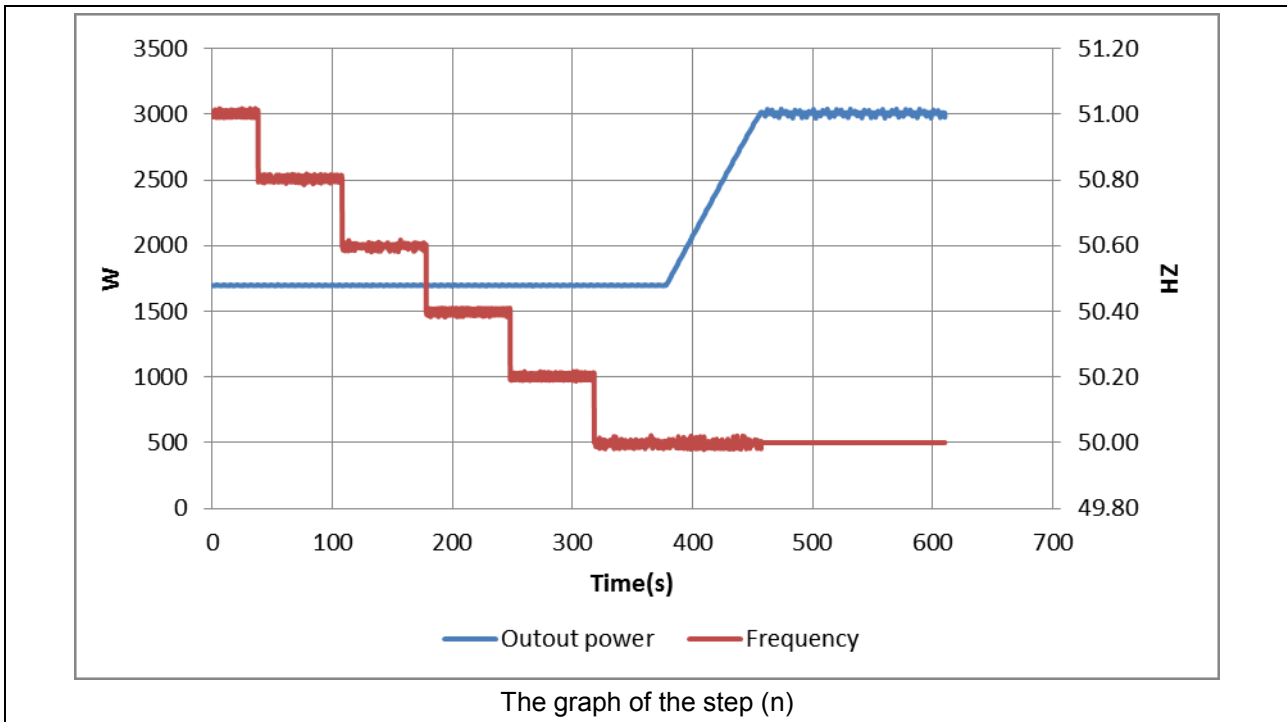

Appendix H3.4		Test procedure for inverters with energy storage		P
(c) Test at 50 ±5% rated apparent power (VA):	1650	F <sub>stop</sub> (Hz):	49	
(d) The average inverter power for 5 min P <sub>ref</sub> (W):	1647.1			
(f) Output frequency (Hz)	Average frequency (Hz)		Charge power (W)	
49.9	49.9		1647.10	
49.8	49.8		1646.30	
49.7	49.7		1645.70	
49.6	49.6		1431.60	
49.5	49.5		1185.40	
49.4	49.4		936.45	
49.3	49.3		692.20	
49.2	49.2		456.80	
49.1	49.1		211.30	
49.0	49.0		0	
48.9	48.9		0	
48.8	48.8		0	



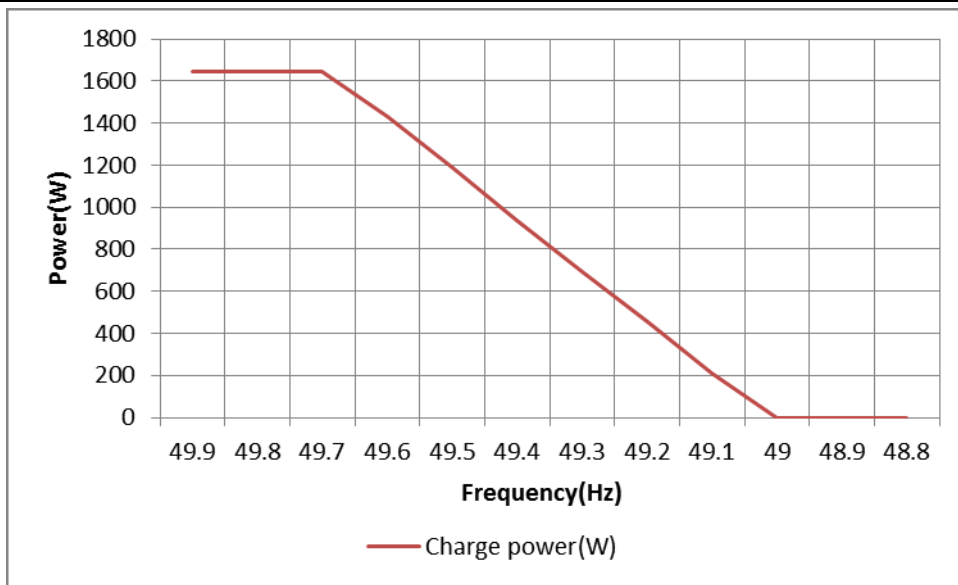

The graph of the step (f)

(i) Measured hysteresis time (s)		63.0
Hysteresis limit (s)		> 60
Increase power rate (W/min.):		479.85
Rated charge power (W)		3000
Increase power rate based on rated power output (%):		15.99
Power rate limit $W_{Gra}$ (%):		15.00 - 18.33
(j)	Repeat (c) Test at $50 \pm 5\%$ rated apparent power (VA):	1650
	Repeat (d) The average inverter power for 5 min $P_{ref}$ (W):	1644.44
(k) Output frequency (Hz)	Average frequency (Hz)	Charge power (W)
49.9	49.90	1641.48
49.8	49.80	1645.23
49.7	49.70	1638.17
49.6	49.60	1431.65
49.5	49.50	1185.80

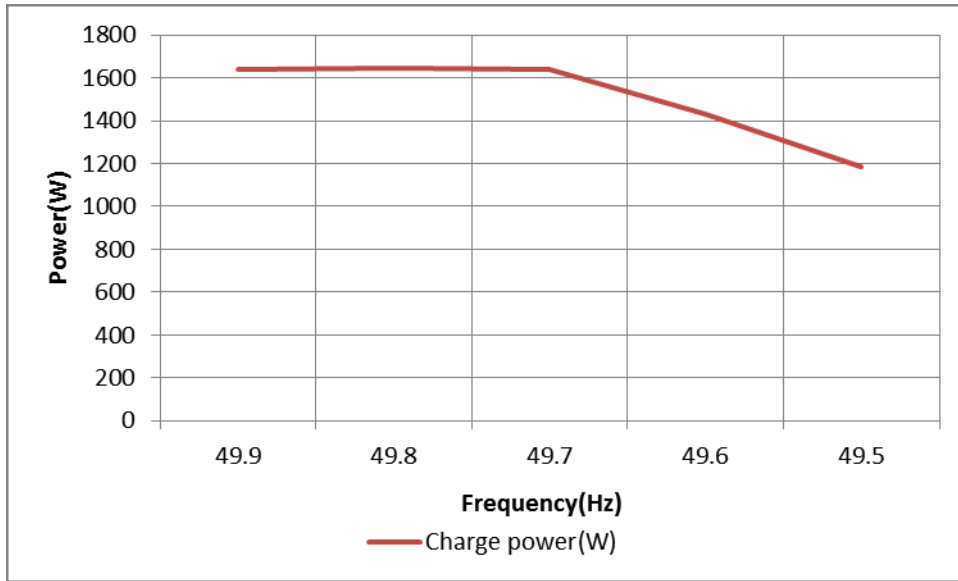

The graph of the step (k)

(m) Output frequency (Hz)	Average frequency (Hz)	Charge power (W)
49.5	49.50	1185.80
49.6	49.60	1176.81
49.7	49.70	1177.59
49.8	49.80	1177.19
49.9	49.90	1645.96
(n) Increase power rate (W/min.):		487.36
Rated charge power (W)		3000
Increase power rate based on rated power output (%)		16.24
Power rate limit $W_{Gra}$ (%)		15.00 - 18.33

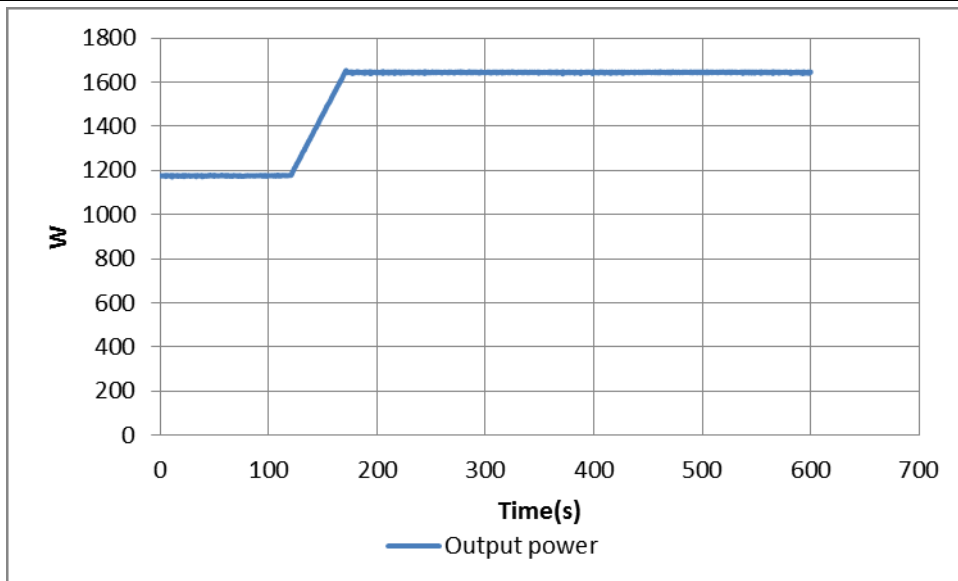

Appendix I	DEMAND AND POWER QUALITY RESPONSE MODE TESTING INCLUDING DISCONNECTION ON EXTERNAL SIGNAL			P
Demand response test	Real power(W)	Reactive power(Var)	Switching time(s)	Pass/ Fail
DRM 0 at 100%	0	0	0.638	Pass
DRM 7	--	--	--	--
DRM 6 and DRM 7	--	--	--	--
DRM 6	--	--	--	--
DRM 5 and DRM 6	--	--	--	--
DRM 8	--	--	--	--
DRM 3	--	--	--	--
DRM 3 and DRM 2	--	--	--	--
DRM 2	--	--	--	--
DRM 1 and DRM 2	--	--	--	--
DRM 4	--	--	--	--